



SERVICE MANUAL

MB23 and MB25

Moisture Analyzers





SERVICE MANUAL
MB23 and MB25
Moisture Analyzers

The information contained in this manual is believed to be accurate at the time of publication, but Ohaus Corporation assumes no liability arising from the use or misuse of this material. Reproduction of this material is strictly prohibited.

Material in this manual is subject to change.

© Copyright 2010 Ohaus Corporation, all rights reserved.
TM Registered trademark of Ohaus Corporation.

TABLE OF CONTENTS

CHAPTER 1 GETTING STARTED	Page No.
1.1 Introduction.....	1-1
1.2 Service Facilities.....	1-1
1.3 Tools and Test Equipment Required.....	1-2
1.4 Specifications.....	1-3
1.5 Analyzer Operation.....	1-4
1.5.1 Overview of the Controls.....	1-4
1.5.2 Overview of the Display Indicators.....	1-4
1.5.3 Operating Modes.....	1-5
1.5.4 Power.....	1-7
1.5.5 Power On & Off.....	1-7
1.6 Communications Interface.....	1-8
CHAPTER 2 TROUBLESHOOTING	
2.1 Troubleshooting.....	2-1
2.1.1 General Procedures for Troubleshooting.....	2-1
2.2 Error Codes.....	2-2
2.3 Problem Solver.....	2-4
CHAPTER 3 MAINTENANCE PROCEDURES	
3.1 Preventive Maintenance.....	3-1
3.1.1 Preventive Maintenance Checklist.....	3-1
3.2 Opening the MB23 and MB25.....	3-1
3.3 Preliminary Checks of the Top Housing Components.....	3-4
3.3.1 Test the Heater Circuit.....	3-4
3.3.2 Test the Temperature Sensor and Cable.....	3-4
3.3.3 Test the Fan.....	3-4
3.3.4 Test the Ground Circuit on the MB23.....	3-4
3.4 Testing the Power PCB.....	3-5
3.5 Replacing the Power PCB.....	3-5
3.6 Replacing the Main PC Board.....	3-6
3.6.1 Replacing the Display LCD.....	3-6
3.7 Replacing the Load Cell.....	3-7
3.8 Repairing and/or Replacing the Heating Unit Parts.....	3-8
3.8.1 Testing the Heater Circuit.....	3-8
3.8.2 Removing the Heater on the MB23.....	3-9
3.8.3 Removing the Heater on the MB25.....	3-10
3.8.4 Replacing the Heater on the MB25.....	3-10
3.8.5 Replacing the Heater on the MB23.....	3-11
3.8.6 Testing the Thermal Overload Device.....	3-11
3.8.7 Replacing the Thermal Overload Device.....	3-12
3.8.8 Replacing the Fan.....	3-13
3.8.9 Replacing the Temperature Sensor.....	3-14
3.9 Installing the Top Housing.....	3-15
CHAPTER 4 FINAL TESTING	Page No.
4.1. Final Testing.....	4-1
4.2 Operational Test.....	4-1
4.3 Segment Display Test.....	4-1
4.4 Performance Tests.....	4-1

TABLE OF CONTENTS

CHAPTER 4 FINAL TESTING <i>continued</i>	Page No.
4.4.1 Precision Test.....	4-2
4.4.2 Repeatability Test.....	4-3
4.4.3 Linearity Test.....	4-4

CHAPTER 5 DRAWINGS AND PARTS LISTS

5-1 MB23 and MB25: Housing & Internal Parts	5-2
---	-----

Appendix A STANDARD CALIBRATION

A.1 Weight Calibration	A-1
A.2 Temperature Calibration	A-2
A.3 Service Calibration.....	A-3

Appendix B SERVICE CALIBRATION & SOFTWARE SERVICE TOOL

B.1 Restore EEPROM Data	B-2
B.2 Replace Load Cell	B-3
B.3 Update Software in the Analyzer	B-4
B.4 Diagnostics	B-5
B.5 Service Calibration.....	B-5

LIST OF TABLES

TABLE NO.	TITLE	Page No.
1-1	Specifications	1-3
1-2	Functions of Display Controls.....	1-4
2-1	Error Codes.....	2-2
2-2	Problem Solver.....	2-4
4-1	Types of Performance Tests & Tolerances	4-1
5-1	MB23 & MB25: Housing & Internal Parts	5-3

LIST OF ILLUSTRATIONS

FIGURE NO.	TITLE	
1-1	MB23 and MB25 Function Labels	1-4
1-2	MB23 & MB25 Display Indicators.....	1-4
1-3	AC Power	1-7
1-4	RS232 DB9-pin setup.....	1-8
1-5	Solder Points on PCB.....	1-8
3-1	MB25 with Top Open.....	3-2
3-2	Housing Chamber	3-2
3-3	Lifting Out Plug in Housing.....	3-2
3-4	Clear Plastic In-use Cover.....	3-2
3-5	Three screws in Top Housing.....	3-2
3-6	Lifting the Housing.....	3-3
3-7	Fan, Temperature Sensor, Heater cable connectors on Power PCB.....	3-3
3-8	Cables for Temperature Sensor, Fan, Ground and Heater disconnected.....	3-4
3-9	Power PCB Connectors	3-5
3-10	Power PCB.....	3-5
3-11	Load Cell Cover	3-6
3-12	Main Printed Circuit Board	3-6
3-13	Display LCD on Main PCB	3-6
3-14	Load Cell	3-7
3-15	Load Cell with Ribbon Cable Attached at Bottom	3-7
3-16	Screws Holding Chamber Top to the Heater Frame Housing	3-8

TABLE OF CONTENTS

FIGURE	TITLE	Page No.
3-17	Separating the Chamber Top from the Heater Frame Housing	3-8
3-18	Testing Heater Leads' Resistance	3-8
3-19	Screws and Washers that Secure the Reflector.....	3-9
3-20	MB23: Screws and washers anchoring cables on each side of Heater	3-9
3-21	Spring Tab on Connector	3-9
3-22	Lifting Out the Heater (MB23)	3-9
3-23	Screw and washer anchoring Heater Cables	3-10
3-24	Lifting Out the Heater (MB25)	3-10
3-25	MB23: Installing the Heater	3-11
3-26	Reset Button on the Thermal Overload Device.....	3-11
3-27	MB25 Thermal Overload Device	3-12
3-28	MB23 Thermal Overload Device	3-12
3-29	MB 25 Thermal Overload Device Installed.....	3-12
3-30	Screws in Fan Plate	3-13
3-31	Grommets Slide Out from the Bottom Plate	3-13
3-32	Lid Position Rod and Spring under the Fan Plate	3-13
3-33	Removing the Fan.....	3-12
3-34	Removing Screw to Access Temperature Sensor Cable	3-14
3-35	Removing Clip that Secures Heater, with Needle Nose Pliers.....	3-14
3-36	Removing Screws and Washers Securing Temperature Sensor	3-14
3-37	Connecting Cables to the Power PCB	3-15
3-38	Placing Plug on Top Housing	3-15
3-39	Installing Protective Glass.....	3-15
3-40	Clear plastic In-use Cover	3-16
3-41	Housing Chamber	3-16
3-42	MB25 with top open	3-16
4-1	Segment Display	4-1
5-1	MB23 & MB25: Housing & Internal Parts	5-2
A-1	Temperature Calibration Kit installed	A-1
B-1	Com Port Configuration Menu.....	B-1
B-2	The Software Service Tool's Restore EEPROM Tab	B-2
B-3	The Software Service Tool's Replace Load Cell Tab.....	B-3
B-4	The Software Service Tool's Download Software Tab	B-4
B-5	The Software Service Tool's Diagnostics Tab.....	B-5

TABLE OF CONTENTS

1.1 INTRODUCTION

This service manual contains the information needed to perform routine maintenance and service on the MB23 and MB25 Moisture Analyzers. Familiarity with the Instruction Manual is assumed. The contents of this manual are contained in five chapters:

Chapter 1 Getting Started – Contains information on service facilities, tools, specifications, and the mechanical and electronic functions of the product.

Chapter 2 Troubleshooting – Contains a diagnostic guide and error code table.

Chapter 3 Maintenance Procedures – Contains preventive maintenance procedures and disassembly, repair and replacement procedures.

Chapter 4 Testing – Contains a list of required test masses, an operational test, segment display test, performance tests and adjustments.

Chapter 5 Drawings and Parts Lists – Contains exploded views of MB23 and MB25 Moisture Analyzers identifying all serviceable components.

Appendix A Standard Calibration – Explains procedures for Standard Calibration, performed prior to use and after service.

1.2 SERVICE FACILITIES

The service area should meet the following requirements:

- Should be temperature controlled and meet specifications for temperature environmental requirements.
- Must be free of vibrations such as fork lift trucks close by, large motors, air currents or drafts from air conditioning/heating ducts, open windows, people walking by, fans, etc.
- Area must be clean and free of excessive dust.
- Work surface must be stable and level.
- Moisture Analyzers must not be exposed to direct sunlight or radiating heat sources.
- Use an approved Electro-Static Device.

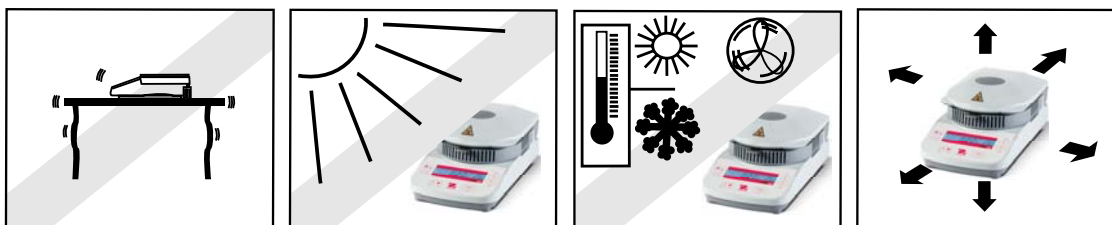

1.3 TOOLS AND TEST EQUIPMENT REQUIRED

1. Digital Voltmeter (DVM) - Input impedance of at least 10 megohms in 1 Volt dc position.
2. Standard electronics tool kit
3. Soldering iron (50 watt) and solder (rosin core solder, not acid core).
4. Solder remover
5. Ohaus Temperature Calibration Kit P/N 11113857
6. 50g calibration weight
7. Strain Gage Simulator (optional)
8. Soft, lint-free cleaning cloth
9. Anti-static bags for PCBs
10. Anti-static wrist strap and mat
11. RS232 Cable, P/N 80500525

1.4 SPECIFICATIONS

Complete specifications for the Ohaus MB23 and MB25 Moisture Analyzers are listed in Table 1-1. When a scale has been serviced, it must meet these specifications.

TABLE 1-1. SPECIFICATIONS

Model	MB25	MB23
Capacity	110g	
Repeatability (Std Dev) (g)	0.2% (3g sample) 0.05% (10g sample)	0.3% (3g sample) 0.2% (10g sample)
Readability (% requires >10g sample)	0.005g; 0.05%	0.01g, 0.1%
Linearity (d)	±2	
Off Center Load (½ cap, ½ dist)	5d	
Tare range	To capacity by subtraction	
Stabilization Time	≤3 seconds	
Calibration – Weight	External Calibration Mass, 50g	
Calibration – Temperature	OHAUS Temperature Calibration Kit	
Temperature Settings	50°C to 160°C (5° increments)	
Temperature Readability	±5°C	
Temperature Repeatability	±5°C	
Thermal Overload Protection	Bimetalic-element switch in dryer unit	
Temperature Adjustments	2 points, 100°C and 160°C	
Operating Temperature Range	41°F to 104°F / 5°C to 40°C	
Operating Humidity Range	10% - 85% (RH) non-condensing	
Shipping & Storage Temp.	– 40°C (– 40°F) to 60°C (140°F) at 10% to 95% RH, non-condensing	
Heating Technology	Halogen	Infrared (no glass)
Power Requirement	100 to 240 VAC, 50/60 Hz	

1.5 ANALYZER OPERATION

This section contains information on the basic operation of the scale.

1.5.1 Overview of the Controls

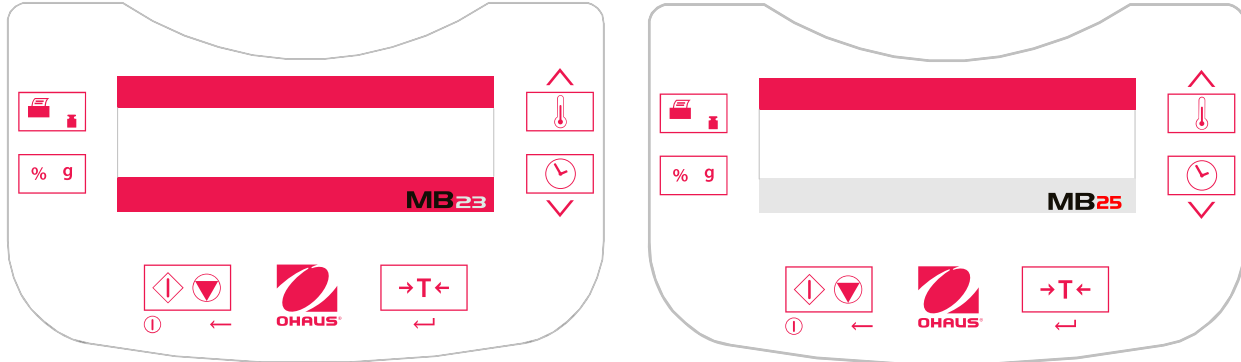

Figure 1-1. MB23 and MB25 Function Labels.

TABLE 1-2. FUNCTIONS OF DISPLAY CONTROLS

Button:	Name:	Functions:	Button:	Name:	Functions:
	Start/Stop	On (short press)/Off (long press) Start/Stop (short press) Back (short press)		Set ▲	Increase value (short or long press)
	Tare	Tare (short press) Enter/Accept value (short press)		Set ▼	Decrease value (short or long press)
	Temp	Temperature Setting (short press)		Print/Cal	Print (short press) Calibrate (long press)
	Time	Time Setting (short press)		%g	Result Unit (short press)

There are also several modes of operation which affect how each button operates. Please refer to the following section.

1.5.2 Overview of the Display Indicators

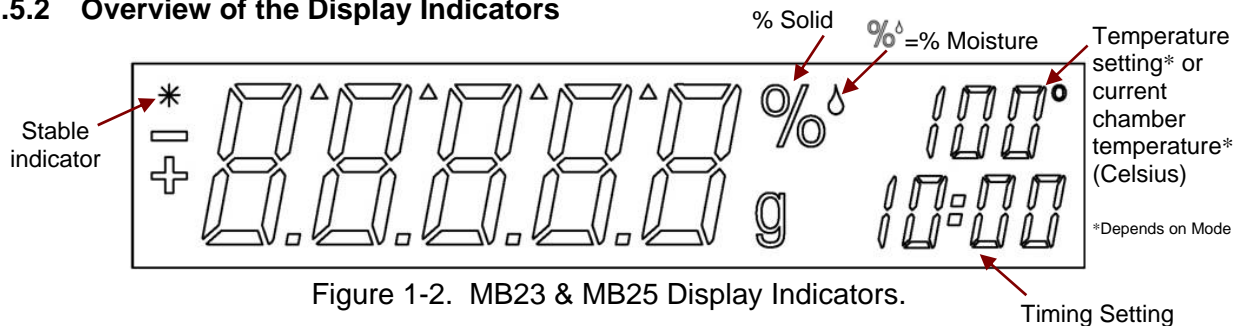

Figure 1-2. MB23 & MB25 Display Indicators.

1.5.3 Operating Modes

Standby Mode

When Analyzer is connected to AC power and display is off, the unit is in Standby mode.

 (Short press) Turns on the display and enters Weigh mode.

Weigh Mode

The display shows the weight of items placed on the pan support.

 (Short press) Sets the displayed weight value to zero.

 (Long press) Enters Standby mode (Off).

After power on, the following operations can be initiated:

 (Short press) Enters Edit mode for the temperature setting, the value will blink.

 (Short press) Enters Edit mode for the time setting, the value will blink.

 (Short press) Activates Run mode, initiates test with sample greater than 0.5g.

 (Long press) Initiates weight or temperature Calibration (See Appendix A.)

Temperature/Time Edit Mode (Preparing a Test)

Temperature editing: (50° to 160°C in 5° steps)

 (Short press) Enters Edit mode for the temperature setting, the value will blink.

 (Short or long press) Increases the value of the temperature setting.

 (Short or long press) Decreases the value of the temperature setting.

 (Short press) Accepts the blinking value and returns to Weigh mode.

 (Short press) Exits Edit mode without saving changes.

Note: After 5 seconds of no activity the blinking setting is automatically saved and the mode returns to Weigh mode.

Time editing: (1 to 60 minutes in 30 second steps, 61 to 99 minutes in 1 minute steps)

The time parameter can be set to timed duration or AUTO (test ends when Analyzer detects the weight loss has ended).

Selecting **AUTO** or timed duration:)

 (Short press) Enters Edit mode for the time setting. The value will blink.





 (Short press while time setting blinks) Toggles between **AUTO** and time value.

 Accepts the blinking setting.

If **AUTO** is selected: Weigh mode is entered.

1.5.3 Operating Modes *continued*

If **Time Duration** is selected:

-  (Short or long press) Increases the value of the time setting.
-  (Short or long press) Decreases the value of the time setting.
-  (Short press) Accepts the blinking value and returns to Weigh mode.
-  (Short press) Exits Edit mode without saving changes.





Note: After 5 seconds of no activity the blinking setting is automatically saved and the mode returns to Weigh mode.

Run Mode (Performing a Test)

A moisture determination test is initiated. The results in progress are displayed.



NOTE: To setup a test:

1. Place a container on the Pan, and press **Tare**.
2. Place mass to be tested (>0.5g) on Pan. Then press **Start**, as below.

-  (Short press) Activates Run mode, initiates test with sample greater than 0.5g.
-  Changes the unit of displayed result: toggles between **weight (grams)** -> **% Moisture** -> **% Solids**.
-  (Short press) Stops test in progress.
-  Sends current displayed value to the RS232.

Result Mode

At the end of the test (Run Mode), the display blinks the test result.

-  Changes the unit of displayed result: weight (grams) > % Moisture > % Solids.
-  Exits to Weigh mode.
-  Sends current displayed value to the RS232.

1.5.4 Power

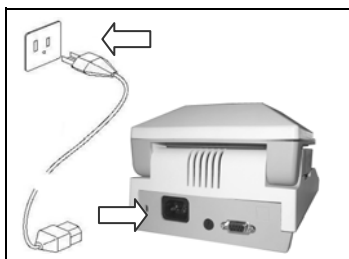

Verify that the input voltage printed on the voltage identification label information and the plug type matches the location's AC power supply.

Connect the supplied power cable to the power input receptacle at the rear of the Analyzer and into a properly grounded power outlet.

Figure 1-3. AC power .



Follow these safety precautions when servicing or using the Moisture Analyzer:

- The Analyzer has a 3-pin power cable that includes a ground connection. Intentionally disabling the equipment grounding connection is prohibited.
- Disconnect the Analyzer from the power supply when cleaning.

1.5.5 Power On & Off



On short press; **Off/Standby Mode** long press

When powered on from standby mode, Analyzer is ready for immediate use.

Allow time for the Analyzer to stabilize after moving it from an area which is at a different temperature than the area where it is to be operated. Allow one hour for each 5°F (2.7°C) temperature change before using the unit. After temperature stabilization, allow an additional 20 minutes after turning the unit on, for the electronics to stabilize.

When the scale is first turned on, the factory default is to weigh (in grams) and tare items without setting the menus.

1.6 Communications Interface

The MB23 and MB25 are equipped with a bi-directional RS232 interface, accessed through a DB9-pin connector on the rear of the unit. Following are available parameters (defaults in bold):

1. **Baud Rate:** 1200; **2400**; 4800; 9600; 19,200
2. **Parity:** Odd, Even, **None**
3. **Data Bits:** **7**, 8
4. **Stop Bits:** 1, **2**
5. **Handshake:** None, XON-XOFF, RTS-CTS

DB9 Connections

- Pin 1: Jumper required (J2) for Remote Tare operation*
- Pin 2: Balance transmit line: TxD
- Pin 3: Balance receive line: RxD
- Pin 4: Shorted to Pin 6.
- Pin 5: Ground signal: GND
- Pin 6: Shorted to Pin 4.
- Pin 7: Clear to send (hardware handshake): CTS
- Pin 8: Request to send (hardware handshake): RTS
- Pin 9: Jumper required (J1) for Remote Print operation*

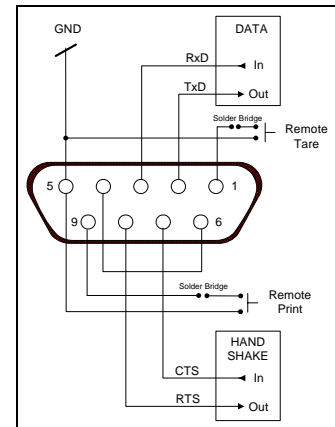

Figure 1-4. RS232 DB9-pin setup.



Note: After installing the jumper for remote operation, ensure that wires are protected from static discharge.

* To enable External PRINT and/or ZERO/ TARE functions, join the solder points for Tare (J2) and Print (J1), on the Main PCB:

1. Locate solder points J1 and J2 on the Main PCB, above the Display LCD.
2. Using a low wattage soldering iron, apply a small amount of solder to:
 - Join two points at J2 to enable Tare.
 - Join two points at J1 to enable Print.

Join the points by filling the gap:

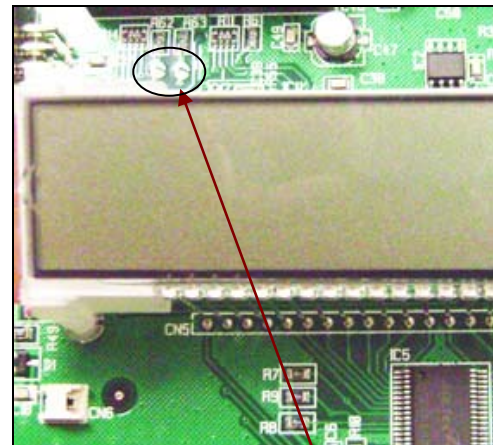

Figure 1-5. Solder points on PCB.

2.1 TROUBLESHOOTING

This section of the manual provides a standard troubleshooting methodology. Follow all directions step by step. Make certain that the work area is clean. Handle components with care. Use an Electro-Static Device.

2.1.1 General Procedures for Troubleshooting

1. Do the most obvious, user-level remedies.
2. Check that internal parts are clean and free of debris.
3. Consult the Error Code Table (Table 2-1) for solutions to specific codes.
4. Use the Problem Solver (Table 2-2) to locate the symptom. Follow the suggested remedies in the order they appear.
5. **Visual Check:** Examine the Load Cell for signs of bending, twisting or corrosion.
 - Clean the unit before evaluating any mechanical problems. Remove any debris inside the Housing.
 - Examine the Housing for damage, bent parts or signs of physical abuse. Replace all damaged parts. See Chapter 5 for parts list.
 - Check the cables leading to the Load Cell for cuts, abrasions or other signs of damage.
 - Examine the Load Cell for corrosion due to high humidity or exposure to chemicals. A Load Cell that is even slightly bent or corroded should be replaced.
 - Check the heating unit for corrosion or other damage.

If a problem arises that is not covered in this manual, contact your local Ohaus office.

2.2 Error Codes

When a problem occurs, the display may indicate an error code. Table 2-1 describes the various error codes and specifies the probable cause and remedy.

TABLE 2-1. ERROR CODES

ERROR	PROBABLE CAUSE	REMEDY
Err 7.0	Time out Defective Main PCB.	Turn unit off and then back on. Replace Main PCB. Section 3.6.
Err 8.1	Pan Support has load during power on. Dirt or debris in unit. Defective Load Cell. Defective Main PCB.	Remove weight from Pan Support. Clean the unit thoroughly. Replace Load Cell. Section 3.7. Replace Main PCB. Section 3.6.
Err 8.2	Pan Support removed during power on, or dirty Pan Support. Load Cell defective. Main PCB defective.	Install Pan Support. Be sure it's clean. Replace Load Cell. Section 3.7. Replace Main PCB. Section 3.6.
Err 8.3	Weight on Pan Support exceeds capacity. Dirt or debris in unit.	Remove weight from Pan Support. Perform troubleshooting steps. Section 2.1. Clean the unit thoroughly.
Err 8.4	Pan Support was removed during weighing. Dirt or debris in unit.	Re-install Pan Support. Perform troubleshooting steps. Section 2.1. Clean the unit thoroughly.
Err 9.5	Factory calibration data corrupted.	Use Software Service Tool to restore EEPROM. Appendix B.
Err 10.3	Temperature Sensor out of range – high	Check/Replace cables. Section 3.3.2. Check/Replace Sensor. Section 3.8.9. Replace Main PCB. Section 3.6.
Err 10.4	Temperature Sensor out of range – low	Check/Replace cables. Section 3.3.2. Check/Replace Sensor. Section 3.8.9. Replace Main PCB. Section 3.6.
Err 10.5	Temperature Sensor defective	Check/Replace cables. Section 3.3.2. Check/Replace Sensor. Section 3.8.9. Replace Main PCB. Section 3.6.
Err 10.6	Temperature Sensor defective	Check/Replace cables. Section 3.3.2. Check/Replace Sensor. Section 3.8.9. Replace Main PCB. Section 3.6.
Err 11.0	AC power is unstable	Use a Power Line Conditioner

TABLE 2-1. ERROR CODES

ERROR	PROBABLE CAUSE	REMEDY
Err 53	EEPROM Checksum error Defective ribbon cable. Main PCB defective.	Cycle power. Check cable from Main PCB to Load Cell. Replace Main PCB. Section 3.6.

2.3 Problem Solver

TABLE 2-1. PROBLEM SOLVER

Symptom	Possible Cause	Remedy
Cannot turn on.	Power cord not plugged in or no power supply voltage. Defective main fuse. Defective power supply fuse. Defective Power PCB. Cable connections inside instrument not plugged in or defective. Defective Main PCB.	Verify connections and voltage. Check fuse on back of instrument. Replace power supply fuse. Figure 3-10. Replace Power PCB. Section 3.5. Plug in or replace cable. Replace Main PCB. Section 3.6.
Portions of display do not light up.	Defective display. Defective Main PCB.	Replace Display LCD. Replace Main PCB.
Cannot calibrate	Unstable environment Incorrect calibration masses	Move unit to suitable location. Use correct calibration masses
Heater does not switch on after "Start".	Defective Heater connection or cable. Thermal Overload Device has tripped. Defective temperature sensor cable. Defective Temperature Sensor. Defective Heater. Defective Power PCB. Defective Main PCB.	Test resistance at Heater Connector Plug on Power PCB. Section 3.3.1. Reset Thermal Overload Device. Section 3.8.6. Test Temperature Sensor. Section 3.3.2. Test resistance in Temperature Sensor's plug receptacle. Replace if resistance < 1,000 Ω. Section 3.8.7. Replace Heater. Section 3.8.5. Replace Power PCB. Section 3.5. Replace Main PCB. Section 3.6.
Temperature rises above 180°C.	Defective Temperature Sensor. Defective Power PCB. Defective Main PCB.	Replace if resistance < 1,000 Ω. Section 3.8.7. Replace Power PCB. Section 3.5. Replace Main PCB. Section 3.6.

CHAPTER 2 TROUBLESHOOTING

Symptom	Possible Cause	Remedy
Unstable weight.	Dirt or debris in unit. Cooling air current blocked. Defective Load Cell. Defective Main PCB.	Clean the unit thoroughly. Clean the ventilation grill. Replace Load Cell. Section 3.7. Replace Main PCB. Section 3.6.

3.1 PREVENTIVE MAINTENANCE

Ohaus moisture analyzers are precision instruments and should be carefully handled, stored in a clean, dry, dust-free area, and cleaned periodically. Follow these precautionary steps:

- When a moisture analyzer has had chemicals or liquids spilled on it, all exterior surfaces should be cleaned as soon as possible with warm water on a damp cloth.
- Do not leave a mass on the moisture analyzer when it is not in use.
- Allow time for the moisture analyzer to stabilize after moving it from an area which is at a different temperature than the area where it is to be operated. Allow one hour for each 5°F (2.7°C) temperature change before using the Analyzer. After temperature stabilization, allow an additional 20 minutes after turning the unit on, for the electronics to stabilize.

3.1.1 Preventive Maintenance Checklist

The moisture analyzer should be inspected and checked regularly, as follows:

1. Remove the Pan Handler Pan Support, and Draft Shield to inspect and clean the area beneath the Pan.
2. Clean the outside using a damp cloth with warm water.



CAUTION

DO NOT USE CHEMICAL CLEANERS OR SOLVENTS OF ANY TYPE. SOME CLEANERS ARE ABRASIVE AND MAY AFFECT THE FINISH.

3. Check the Power Cord for broken or damaged insulation.
4. Make a visual inspection for faulty connectors, wiring, and loose hardware.

3.2 OPENING THE MB23 AND MB25

Common hand tools are sufficient to disassemble the MB23 and MB25 moisture analyzers. Turn the Analyzer off and unplug the power cord before you begin.

Warning: Disconnect from power supply and allow heating module to cool!



Use electrostatic protection when servicing!

Electrostatic damage is difficult to detect, because the faults it causes are not clear-cut. MOS switching transistors with electrostatic damage have substantially higher, thermally unstable leakage currents. As a result, the Moisture Analyzer Analyzer drifts more and the display can fluctuate similar to when there is a draft.

To avoid electrostatic damage during production, conducting floors, controlled air humidity, and EMC mats are used. When servicing the unit it is also advisable – as soon as the instrument is opened – to neutralize electrostatic charges.

3.2 OPENING THE MB23 AND MB25 (continued)

1. Lift the top.
2. Remove the Pan Handler, Pan Support and Cleanout Tray. (See Figure 3-1.)
3. Pull away the Housing Chamber:



Figure 3-2. Housing Chamber.

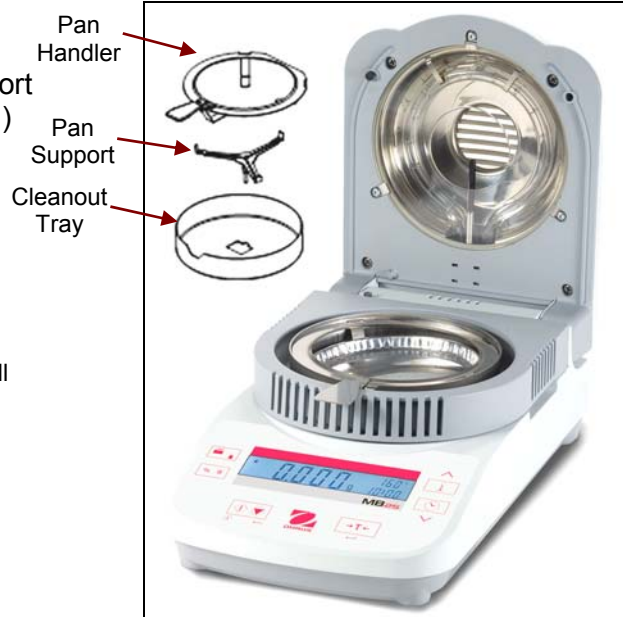

Figure 3-1. MB25 with top open.

4. Lift out the plug in the Housing.
5. Remove the clear plastic In-use Cover that protects the Function Label.

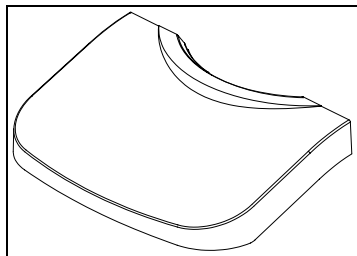

Figure 3-4. Clear plastic In-use Cover.

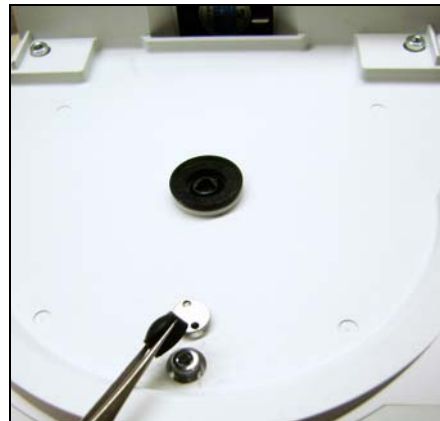

Figure 3-3. Lifting out plug in Housing.

6. Remove the three screws in the Top Housing. (See Figure 3-5.)



Figure 3-5. Three screws in Top Housing.

3.2 OPENING THE MB23 AND MB25 (continued)

7. Gently lift the Top Housing so the rear stays in place and the front rises. (See Figure 3-6.)

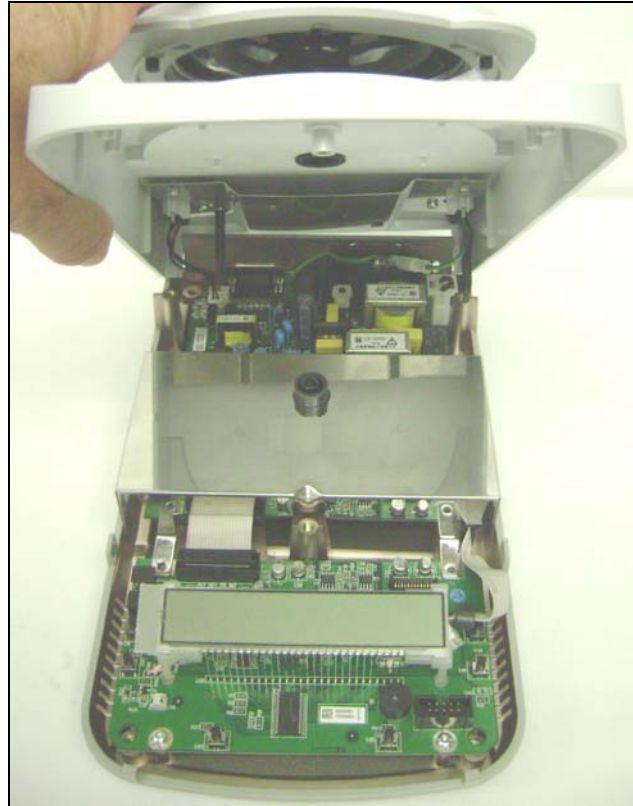

Figure 3-6. Lifting the Housing.

8. Remove the three cables connected to the Power PCB. (Figure 3-7.)
9. On the MB23, disconnect the ground wire. (Not necessary on the MB25.)
10. Lift the Top Housing off and set it aside.

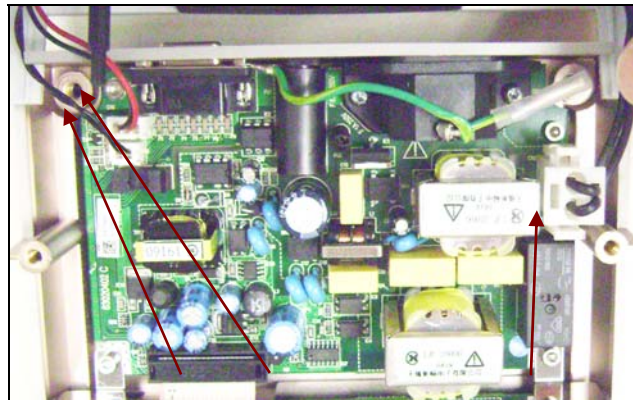

Figure 3-7. Fan, Temperature Sensor, Heater cable connectors on Power PCB.

3.3 PRELIMINARY CHECKS OF THE TOP HOUSING COMPONENTS

Some problems can be identified by testing resistance on cable connector plugs, immediately after opening the Housing: the Temperature Sensor, Heater, Fan, and Ground circuit (on the MB23). It is also possible at this stage to test the Power PCB and Main PCB.

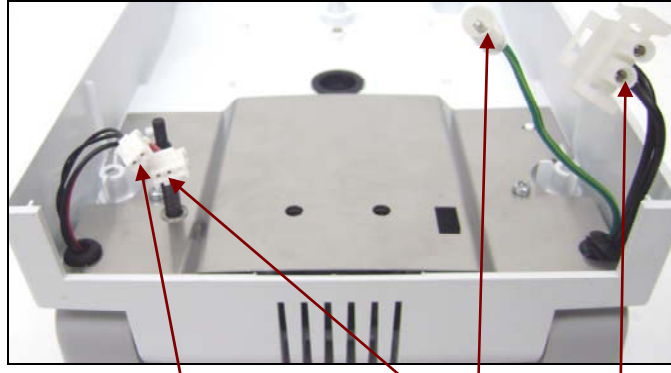

Figure 3-8. Cables for Temperature Sensor, Fan, Ground, and Heater, disconnected.
(**Note:** MB23 shown; MB25 does not require ground cable for heating element.)

3.3.1 Test the Heater Circuit

1. Measure resistance on Heater connector plug: insert probes into plug. (See Fig. 3-8.) If there is no continuity, Thermal Overload, Cables, or Heater may be defective.
2. Open and close Top Housing while checking for an intermittent cable problem. Readings should not fluctuate during this test.
3. Perform tests on Power PCB – see Section 3.4 (next page).

3.3.2 Test the Temperature Sensor and Cable

1. Connect probes to the Temperature Sensor Cable's plug. (See Figure 3-8.)
2. Measure resistance: it should be approximately 1,000 Ω .
3. Open and close the Top Housing while checking for an intermittent cable problem. Readings should not fluctuate during this test.
4. If resistance and flex tests (2 & 3 above) are OK, the Temperature Sensor is good. If not, replace the cable or sensor. (See Section 3.9.7.)



CAUTION:
WHEN CONDUCTING TESTS WITH POWER ON, BE EXTREMELY CAREFUL!
TOUCHING PCB COMPONENTS WITH POWER ON MAY CAUSE SERIOUS INJURY.

3.3.3 Test the Fan

1. Connect AC cord to the analyzer and apply power.
2. Connect pins 18 and 13 on Power PCB Connector CN3. (See Section 3.4.) Fan should run. **Disconnect power before proceeding.**
3. If fan does not run, apply external power to fan. If fan runs, replace the Power PCB.

3.3.4 Test the Ground Circuit on the MB23

1. Connect one probe to the Ground Cable plug, and the other to the Heater.
2. Measure resistance. It should be approximately zero.

3.3.4 Test the Ground Circuit on the MB23 (continued)

- Open and close close Top Housing to check for an intermittent cable problem. If resistance remains zero, the Ground cable is good. If not, replace it.

3.4 TESTING THE POWER PCB



CAUTION:
WHEN CONDUCTING TESTS WITH POWER ON, BE EXTREMELY CAREFUL!
TOUCHING PCB COMPONENTS WITH POWER ON MAY CAUSE SERIOUS INJURY.

- Check Main Fuse. Replace if necessary.
- Check Power Supply Fuse. If defective, replace PCB.
- Disconnect all cables.
- Apply power.
For steps 5 – 7, refer to connector CN3:
- Connect probes to pins 20 and 18: it should read 5 vdc.
- Connect probes to pins 10 and 18, and insert the Lid Position Rod between D+ and E+. Reading should be approx. 3 vdc.
- Jump pins 13 to 18. Measure voltage at CN6. It should read 5 vdc.
- Jump pins 11 to 18. The relay should close. Measure voltage at CN2. It should read approx. 120 vac.

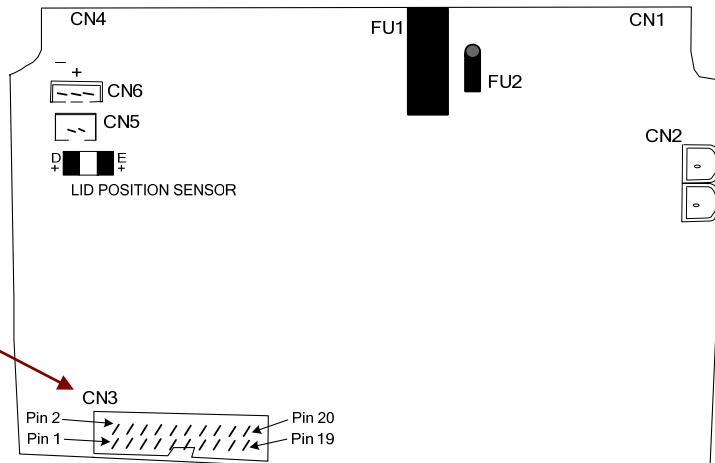

Figure 3-9. Power PCB connectors:

CN4	RS232 Port	CN1	AC Adapter
CN5	Temperature Sensor	CN2	Heater
CN6	Fan	CN3	To Main PCB
FU1	Main Fuse	FU2	Power Supply Fuse

3.5 REPLACING THE POWER PCB

- Open the Housing. (See Section 3.2.)
- Remove the Load Cell Cover. (See Section 3.3.)
- Disconnect the cables from the fan, temperature sensor, heater and ground
- Disconnect the ribbon cable.
- Remove the screws that secure the Power PCB to the bottom housing.
- Install the replacement PCB, insert the screws removed previously.
- Resassemble and calibrate. (See Appendix A.) Perform all tests. (See Chapter 4.)

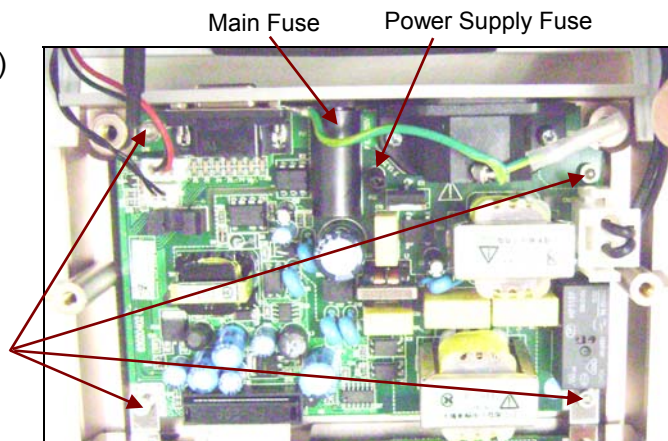

Figure 3-10. Power PCB.

3.6 REPLACING THE MAIN PC BOARD

1. Open the Housing as explained in Section 3.2.
2. Disconnect the Load Cell cable from the Main PCB before lifting off the Load Cell Cover.
3. Remove the four screws on the Load Cell Cover. The two in the Power PCB are machine screws. The two in the Main PCB are self tapping screws. (Note difference for re-assembly.)
4. Lift off the Load Cell Cover.

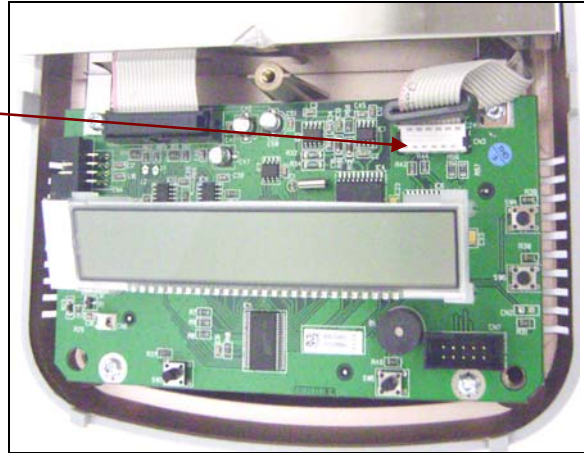

Figure 3-11. Load Cell Cover.

5. Disconnect power cable from the Main PCB.
6. Remove two remaining screws that secure Main PCB to Bottom Housing.
7. Lift out the Main PCB.
8. Install the replacement Main PCB.
9. Reassemble the Moisture Analyzer.
10. Calibrate the Moisture Analyzer. (See Appendix A.) Perform all tests. (See Chapter 4.)

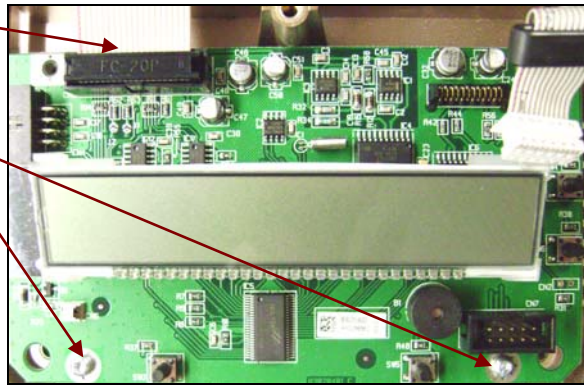

Figure 3-12. Main Printed Circuit Board.

3.6.1 Replacing the Display LCD

1. Follow steps 1 – 6 in Section 3.7.
2. Note location of backlight cables, then remove them.
3. Cut the leads from the old LCD; remove the old LCD.
4. Remove the remaining lead wires; clean solder from the holes.
5. Install new backlight LCD. Position backlight cables like originals, and solder in place.
6. Solder in the LCD leads.

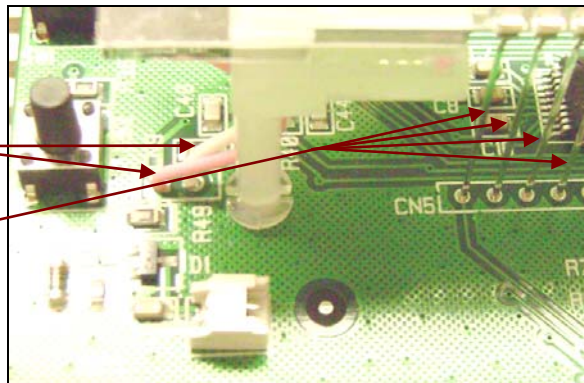

Figure 3-13. Display LCD on Main PCB.

3.7 REPLACING THE LOAD CELL

1. Open the Housing as in Section 3.2; remove the Load Cell Cover, as in Section 3-3.

2. Remove the ribbon cable that connects the two PCBs. (Figure 3-14.)

3. Remove the four screws that secure the Load Cell.

4. Carefully lift up the Load Cell – not all the way. (See next step.)

5. Hold the Load Cell with one hand and gently lift out the ribbon cable from the groove that secures it to the Bottom Housing. (See Figure 3-15.)

6. Lift out the Load Cell.

7. Disconnect the ribbon cable from the old Load Cell, and connect it to the replacement Load Cell.

8. Install the new Load Cell by reversing the steps above.

9. Reassemble the Moisture Analyzer.

10. Install the Load Cell, using the **Software Service Tool**. (See Appendix B.)

11. Calibrate the Moisture Analyzer (See Appendix A.) and Perform all tests. (See Chapter 4.)

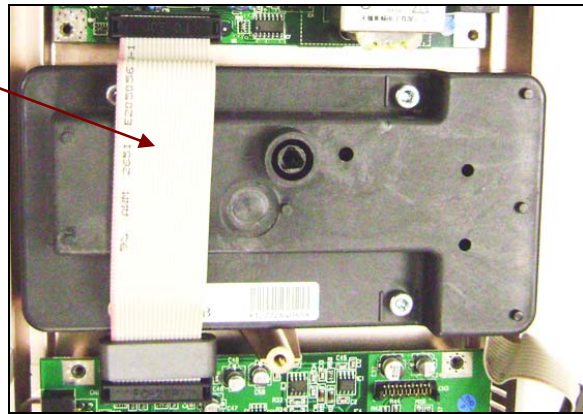

Figure 3-14. Load Cell.

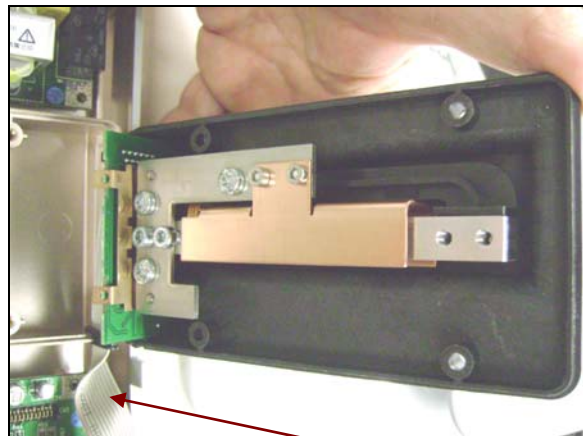

Figure 3-15. Load Cell with ribbon cable attached at bottom.

3.8 REPAIRING AND/OR REPLACING THE HEATING UNIT PARTS

1. Remove the four screws that secure the Chamber Top to the Heater Frame Housing. (See Figure 3-16.)
2. Use a flathead screwdriver to gently pry the Chamber Top from the Heater Frame Housing. (See Figure 3-17.)



Figure 3-16. Screws holding Chamber Top to the Heater Frame Housing.



Figure 3-17. Separating the Chamber Top from the Heater Frame Housing.

3.8.1 Testing the Heater Circuit

1. Perform a **Resistance Test**:
With power to the unit off, use an ohm meter to measure resistance between the Heater's leads. Resistance should be approximately 45 ohms for the MB23, and approx. 5.7 ohms for the MB25.
2. Move the cables while checking to test for an intermittent cable problem. Readings should not fluctuate during this test.
3. If OK, test Thermal Overload Device. (See Section 3.9.4.)
4. If Thermal Overload Device is OK, check fuses on Power PCB.
5. If fuses are OK, replace Power PCB.

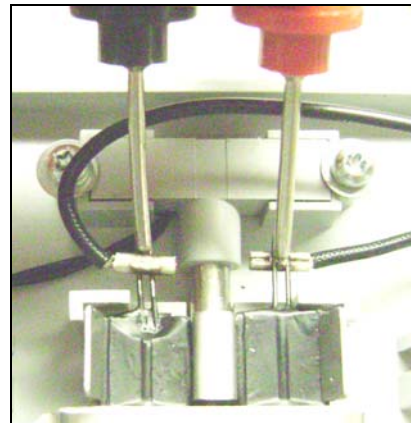

Figure 3-18. Testing Heater leads' resistance.

3.8.2 Removing the Heater on the MB23

1. Remove the screws and washers that secure the Reflector, and lift it off. (See Figure 3-19.)

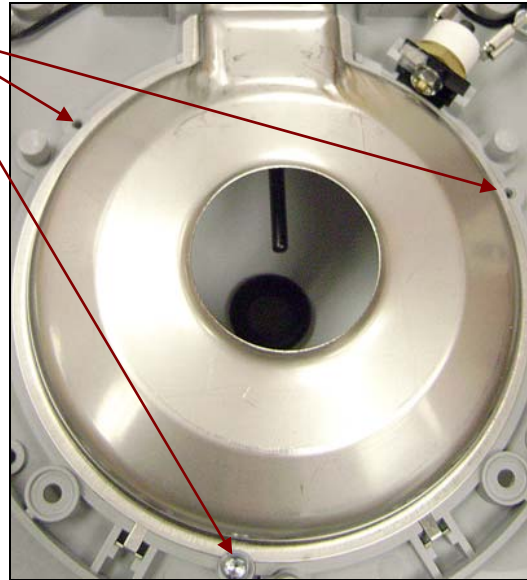

Figure 3-19. Screws and washers that secure the Reflector.

2. Remove the screws and washers that secure the Heater. (See Figure 3-20.)
3. Release the lead connectors on the Heater cables by pressing on the tiny spring tab with the end of a small flat head screwdriver.

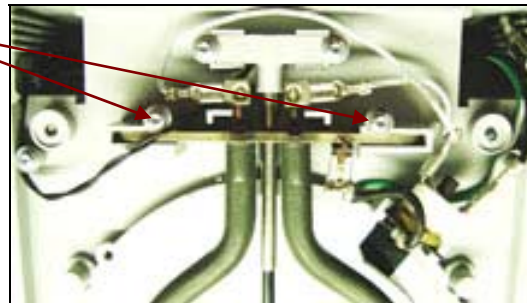
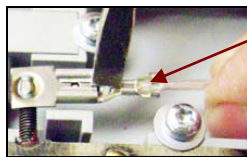

Figure 3-20. MB23: Screws and washers anchoring cables on each side of Heater.



Springtab to release Lead connectors

Figure 3-21. Connector Spring Tab.

4. Grasp the Heater's base and lift it up and out. (See Figure 3-22.) This will release the Heater from the retainer clips opposite.

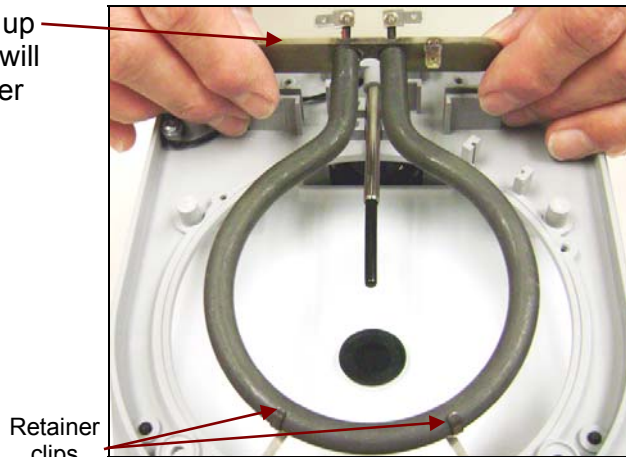

Retainer clips

Figure 3-22. Lifting out the Heater.

3.8.3 Removing the Heater on the MB25

1. Remove the screws and washers that secure the Reflector, and lift it off. (See Figure 3-19.)
2. Remove screw and washer anchoring the cable. (See Figure 3-23.)



Figure 3-23. Screw and washer anchoring Heater Cables.

3. Press outwards on the clips on both sides of the Heater, and gently lift the Heater up and out. (Figure 3-24.)

3.8.4 Replacing the Heater on the MB25

1. Grasp the new Heater by its base, gently press it against the retainer clips opposite, and press it down until it clicks into place.
2. Connect the Heater cables.
3. Install the Reflector.
4. Replace the Chamber Top on the Heater Frame Housing. Insert the four screws that secure Chamber Top to the Heater Frame Housing. (See Figure 3-16.)

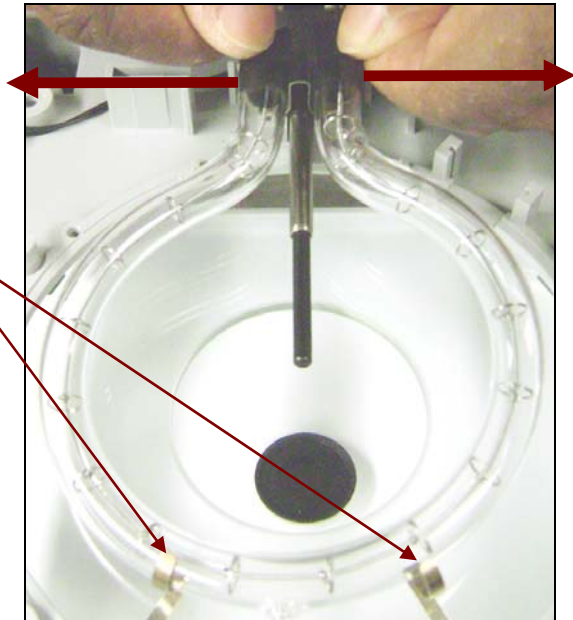

Figure 3-24. Lifting out the Heater.

5. Repeat Heater Circuit Tests. (See Section 3.3.1.)
6. If tests are OK, reassemble the Top Housing. (See Section 3.8.)
7. Perform a Temperature Calibration. (See Appendix A.)

3.8.5 Replacing the Heater on the MB23

1. Grasp the new Heater by its base and gently press it into the retainer clips opposite. (See Figure 3-25.) Insert the base into the slots.
2. Connect the Heater cables.
3. Install the Reflector.
4. Replace the Chamber Top on the Heater Frame Housing.
5. Insert the four screws that secure Chamber Top to the Heater Frame Housing.

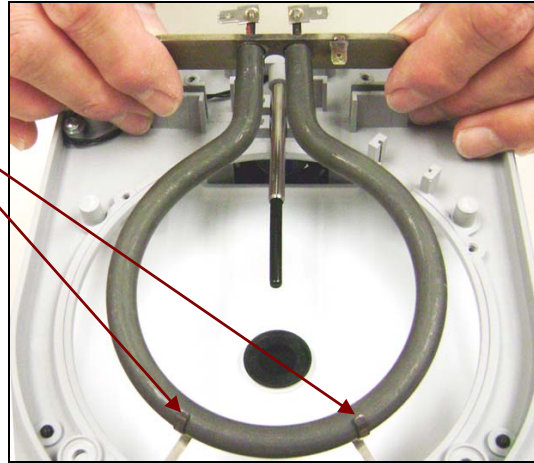

Figure 3-25. MB23: Installing the Heater.

6. Repeat Heater Circuit Tests. (See Section 3.3.1.)
7. If tests are OK, reassemble the Top Housing. (See Section 3.8.)
8. Perform a Temperature Calibration. (See Appendix A.)

3.8.6 Testing the Thermal Overload Device

1. Remove the Chamber Top (Section 3.9.1, Steps 1 and 2) and the Reflector (Section 3.9.2, Step 1.)
2. Perform a continuity test on the Thermal Overload Device: with power to the unit off, use an ohm meter to measure resistance between the device's poles. Resistance should be zero Ω . If so, the device is good. If not, proceed to Step 3.
3. Press the device's reset button. (See Figure 3-26.) Then re-test.
4. If test fails, replace the device.
5. Reassemble the Heating Unit.
6. Perform a Temperature Calibration. (See Appendix A.)
7. Conduct Performance Tests. (See Chapter 4.)

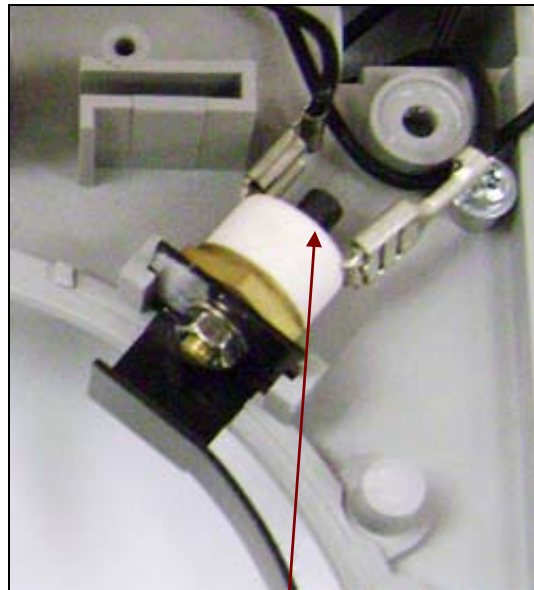

Figure 3-26. Reset button on the Thermal Overload Device.

3.8.7 Replacing the Thermal Overload Device

1. Remove the Chamber Top and Reflector (Sections 3.9.1 and 3.9.2).
2. Remove the cables from the Thermal Overload Device by pressing on the tiny spring with the end of a small flat head screwdriver. (See Figure 3-21.)
3. If the Thermal Overload Device has been disassembled, insert its bolt through the hole in the base of its blade. (See Figure 3-27.)

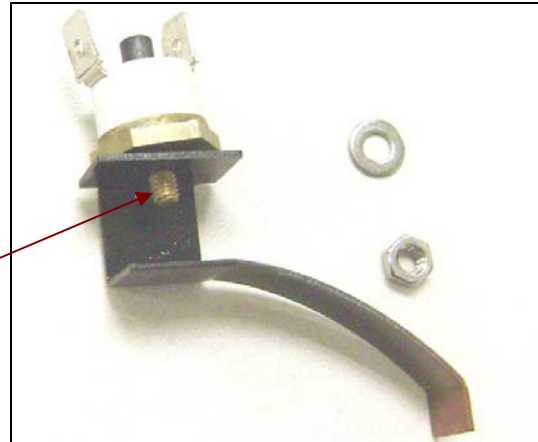

Figure 3-27. MB25 Thermal Overload Device.

4. Fit the washer and then the nut, and use a wrench to tighten the nut.
5. **MB23:** Mount the ground cable ring. (See Figure 3-28.) Then use a wrench to tighten the nut.



Figure 3-28. MB23 Thermal Overload Device.

6. Insert Thermal Overload Device into the grooves provided on the Housing.
7. Connect the cables to the Thermal Overload as shown in Figure 3-29.
7. Reassemble the Heating Unit.
8. Perform a Temperature Calibration. (See Appendix A.)
9. Conduct Performance Tests. (See Chapter 4.)

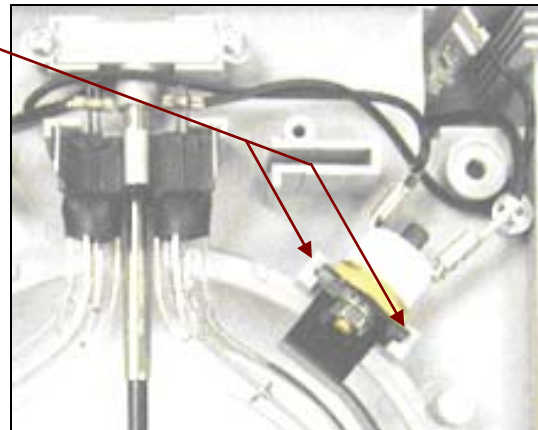

Figure 3-29. MB25 Thermal Overload installed.

3.8.8 Replacing the Fan

The fan is located in the Top Housing. To access it, remove the Top Housing as explained in Section 3.2. The follow these steps:

1. Turn the Heater Unit over and remove the two screws that secure the Fan Plate. (See Figure 3-30.)

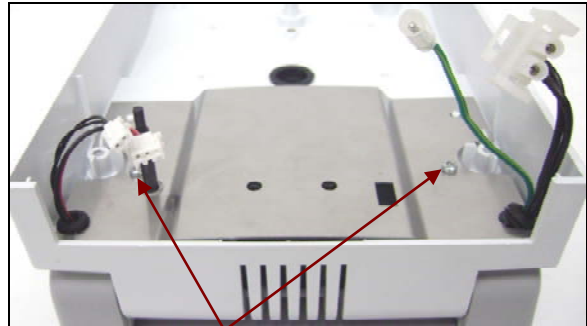

Figure 3-30. Screws in Fan Plate.

4. Lift the Fan Plate and slide out the cable grommets – one each from the left and right sides. (See Figure 3-31.)

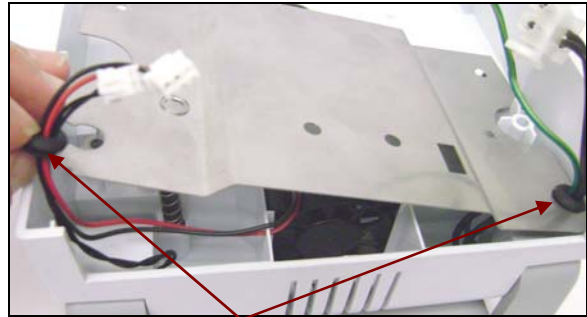

Figure 3-31. Grommets slide out from the Fan Plate.

5. Lift out the Lid Position Rod and spring from under the Fan Plate. (See Figure 3-32.)
6. Draw the cable connectors through the holes in the housing and set them aside.

Note: After reinstalling Lid Position Rod, test its spring action when closing the Heater Unit on the Top Housing.

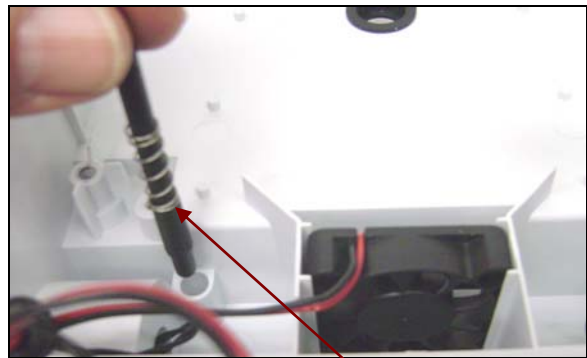

Figure 3-32. Lid Position Rod and Spring under the Fan Plate.

7. Lift out the Fan. (See Figure 3-33.)
8. Gently press back on the Heater Frame Housing, first on one side, then on the other, to release it from the Top Housing.
9. Install the replacement Fan by following these steps in reverse.



Figure 3-33. Removing the Fan.

3.8.9 Replacing the Temperature Sensor

1. Remove the Reflector and Heater, as explained in Section 3.9.2.
2. Remove the screw and washer that secure the Temperature Sensor Cable. (See Figure 3-34.)
3. Lift the Temperature Sensor Cable out of the cavity in the Chamber Top.

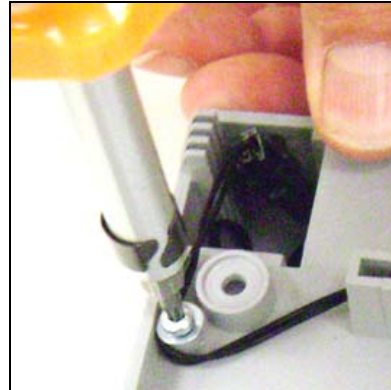

Figure 3-34. Removing screw to access Temperature Sensor Cable.

4. Remove the clip that secures the Heater. (See Figure 3-35.)
5. Remove the screws and washers that secure the Temperature Sensor. (See Figure 3-36.)
6. Lift out the Temperature Sensor.
7. Install the new Temperature Sensor and insert the screws and washers that secure it.

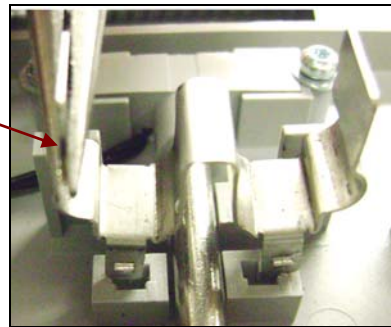

Figure 3-35. Removing clip that secures the Heater, with needle nose pliers.

8. Thread the Temperature Sensor Cable around the plastic post on the side of the Chamber Top Housing, as shown. Insert the screw and washer.
9. Connect the Temperature Sensor Cable.
10. Replace the clip that secures the Heater, the Reflector and the Chamber Top. (See Section 3.9.2.)
11. Reassemble the Heater Unit and Re-install the Top Housing.
12. Perform a Temperature Calibration. (See Appendix A.)
13. If Calibration is successful, conduct Performance Tests. (See Chapter 4.)

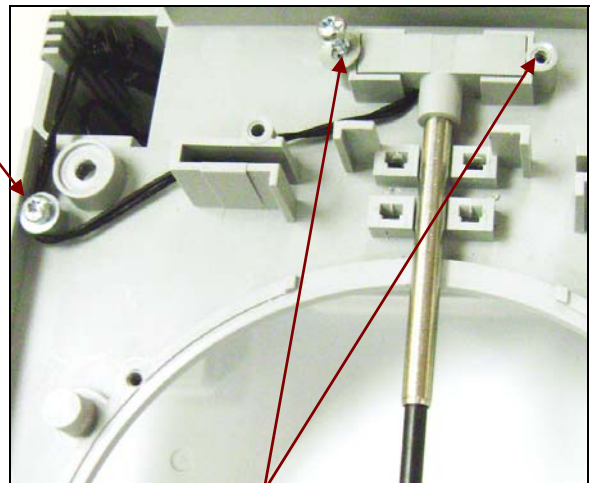

Figure 3-36. Removing screws and washers securing Temperature Sensor.

3.9 INSTALLING THE TOP HOUSING

1. Stand the Top Housing up at the back of the Bottom Housing, so the cables from the heater unit can be plugged in. (See Figure 3-37.)
2. Insert the connectors for the Fan and Temperature Sensor on the left, and the Thermal Overload Device and ground cable (for the MB23) on the right, as shown.

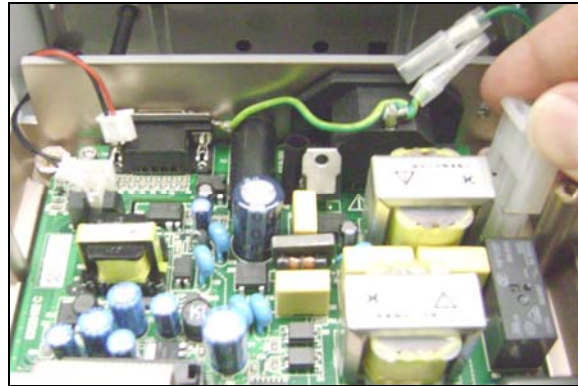

Figure 3-37. Connecting cables to the Power PCB.

3. Install the Top Housing.
4. Double-check that the grommet seal in the center of the Top Housing rests smoothly. If it is twisted, reopen the Housing to set it straight. Otherwise the display will show **Err 8.3** on power up.
5. Insert the three screws to secure the top housing. (See figure 3-38.)
6. Place the small plug over the front screw after tightening it, as shown.

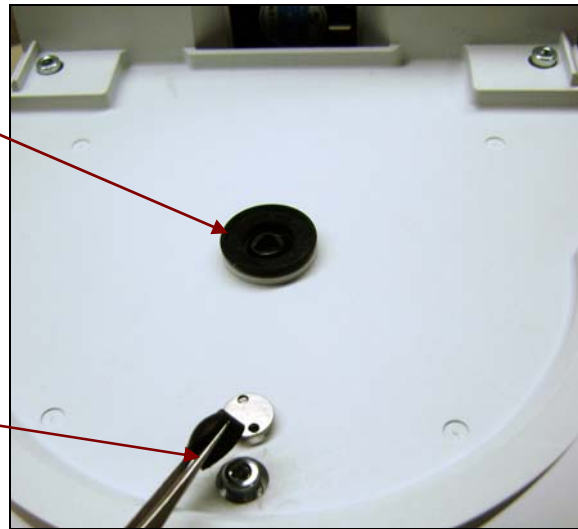

Figure 3-38. Placing Plug on Top Housing.

7. If the Protective Glass on the MB25 was removed or replaced, install it as follows:
8. Place the Protective Glass in the groove in the Heater Frame Housing in front of the Heater.
9. Then place the retainer clips and screws in the holes provided to secure the glass. (See Figure 3-39.)

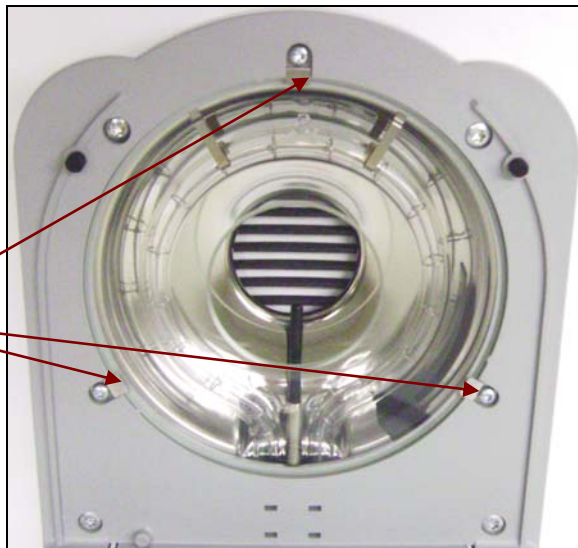

Figure 3-39. Installing Protective Glass.

3.9 INSTALLING THE TOP HOUSING (continued)

10. Place the clear plastic In-use Cover on top of the Function Label.

11. Push in the Housing Chamber:



Figure 3-41. Housing Chamber.

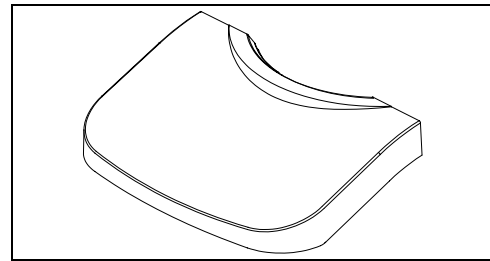

Figure 3-40. Clear plastic In-use Cover.

12. Install the Pan Handler, Pan Support and Cleanout Tray. (See Figure 3-42.)

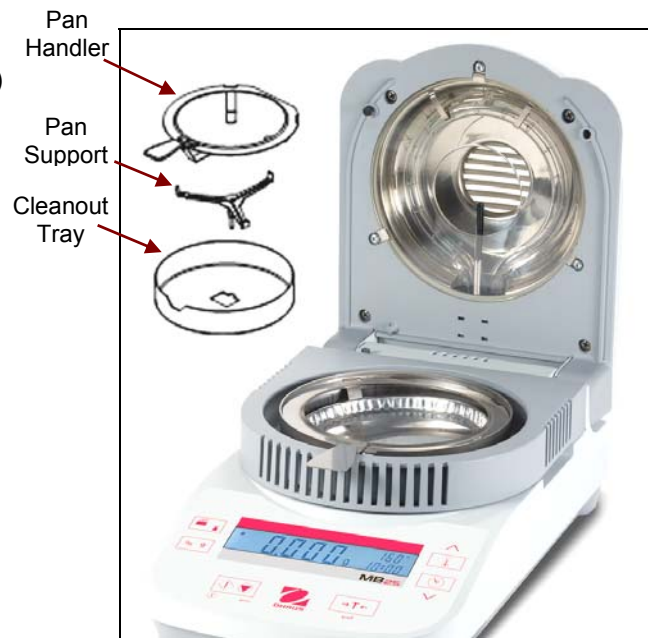

Figure 3-42. MB25 with top open.

4.1 FINAL TESTING

Before servicing the MB23 or MB25 Moisture Analyzer, an operational test and various performance tests should be done to determine if the unit meets specifications. Turn the Moisture Analyzer on and allow it warm up for at least one hour before performing these tests.



NOTE:

Make sure the test area is free from drafts and the surface the Analyzer rests on is level and vibration-free. An ASTM Class 1, or OIML Class E2 Tolerance mass should be used for the performance tests and adjustments.

4.2 Operational Test

Check the Analyzer's voltage rating, and plug the Power Cord into a suitable power source.

4.3 Segment Display Test

Turn the Moisture Analyzer on, and ensure that all segments are enabled and displayed briefly. This is a Segment Display Test. (See Figure 4-1.)

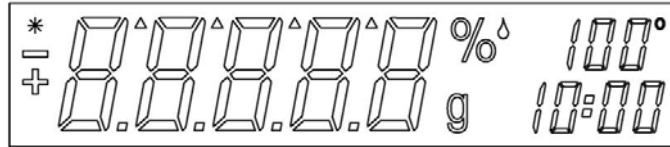

Figure 4-1. Segment Display.

4.4 Performance Tests

Accurate performance is determined by a series of three performance tests: Precision, Off-Center Load and Centered Load. The displayed readings are compared with the tolerances listed in Table 4-1. Before starting the performance tests, level the Moisture Analyzer.

TABLE 4-1. TYPES OF PERFORMANCE TESTS & TOLERANCES

PERFORMANCE TEST	Tolerance: MB25	Tolerance: MB23
Precision (Std Deviation)	±0.2g	±0.3g
Repeatability (Std Dev)	0.2% (3g sample) 0.05% (10g sample)	0.3% (3g sample) 0.2% (10g sample)

The following performance tests are used to evaluate the Moisture Analyzer operation before and after repairs. Each Moisture Analyzer tested must meet the requirements specified in each test as well as the specifications listed in Table 1-1. A Moisture Analyzer which passes each of these three tests meets the manufacturing specifications.

4.4.1 Precision Test

In Analyzer specifications, the term Precision means the Standard Deviation of a set of similar weight readings. To determine if an Analyzer meets the calculated Standard Deviation value in the Specification Table 4-1, perform the following test:

1. Tare the Analyzer. The reading on the display should be 0.000g.
2. Place a 50g mass on the *center* of the sample pan. Observe and record the reading when the stable indicator comes on.
3. Remove the mass. The reading should return to 0.000 within the published tolerance when the stable indicator is on.
4. Repeat this test for ten readings. If the standard deviation of the readings is less than the indicated tolerance, the Analyzer passes the Precision Test.

CAUTION: Remove the mass from the pan after testing.

Adjustment

If the deviation for any set of readings (using the same mass placed on the center of the pan) is greater than the indicated tolerance, the Moisture Analyzer does not meet the Precision Test specification. Inspect and correct the following areas:

1. Check for mechanical obstructions: any foreign object touching any part of the moving pan linkage assembly will cause the Analyzer to fail the Precision Test. Inspect and correct as necessary.
2. An error in the Off-Center Load Test can affect the results of the Precision Test. Inspect and correct if necessary. (See Off-Center Load Test.)
3. Foreign material or debris between the pan and the base will cause the Analyzer to fail the test.
4. Vibrations, drafts or a non-level surface can cause failures.

4.4.2 Repeatability Test

Repeatability is the Standard Deviation of a set of similar readings.

Requirements:

- To perform this test, identical samples must be used for all readings.
- The test sample should be approximately 50 grams.
- Wear gloves when handling the sample.

Before starting a repeatability test, set up the instrument as follows:

TEST PROCEDURE:

1. Zero the instrument.
2. Using a test sample of approximately 50 grams, place the sample on the center of platform. Record the reading on the worksheet provided.
3. Remove the sample from the platform.
4. Repeat this test starting at Step 1 until you record a total of ten readings

Fill in the worksheet (Table 4-2) with the ten (10) readings.

TABLE 4-2. REPEATABILITY WORKSHEET

n	Reading	Delta = Reading – Mean	Delta x Delta
1			
2			
3			
4			
5			
6			
7			
8			
9			
10			
n = number of Reading Mean = Sum of readings / 10 Delta = Reading – Mean Standard Deviation = Square Root of (sum of (Delta x Delta) / 9)			

5. Add the ten readings and divide the total by 10 to find the Mean (average).
6. Mean = (Reading 1 + Reading 2 + Reading 3 + Reading 4 + Reading 5
7. + Reading 6 + Reading 7+ Reading 8 + Reading 9 + Reading 10) / 10

Mean = _____

4.4.2 Repeatability Test

8. Calculate the Delta for each reading and record it in the work sheet.

$$\text{Delta} = \text{Reading} - \text{Mean}$$

9. Calculate the Delta x Delta for each reading and record in worksheet.
10. Add the ten Delta x Delta values and divide by 9
11. Calculate the Standard Deviation by applying the square root of the result from step 8.

Standard Deviation = _____

Note: If the Analyzer does not meet specifications, move it to a suitable location, ensure that it is level, and try again. If it still does not meet specifications, calibrate the unit and try again. (See Appendix A for Calibration.)

4.4.3 Linearity Test

This test is used to determine the linearity of the unit throughout its operating range. The masses used to perform this test can be utility masses.

Note: Due to the use of relative weighing and limited use of the weighing range in moisture analysis, linearity performance is not critical.

Linearity Test Mass

- Reference Mass: 10g
- Load 1: 10g
- Load 2: 40g
- Load 3: 90g

NOTE:

All masses are nominal values. Be certain to use the same reference mass throughout the procedure.

1. Place the reference mass on the pan, record the weight and remove.
2. Place Load 1 on the pan and press TARE.
3. Place the test mass on the pan, record the weight and remove.
4. Place Load 2 on the pan and press TARE.
5. Place the test mass on the pan, record the weight and remove.
6. Place Load 3 on the pan and press TARE.
7. Place the test mass on the pan and record the weight.
8. The difference in the weights of the test mass should be within the Linearity tolerance in Table 1-1. If not, calibrate (see Appendix A.1) and repeat the test.
9. If the unit remains out of tolerance, the Load Cell may need to be replaced.

This section of the manual contains exploded views for the MB23 and MB25 Moisture Analyzers. The exploded view drawings are designed to identify the parts which can be serviced on the Analyzer in the field.

NOTE:

In all cases where a part is replaced, the Analyzer must be thoroughly checked after the replacement is made. The Analyzer **MUST** meet the parameters of all applicable specifications in this manual.

If further technical information is needed, please contact your local Ohaus office, or:

Ohaus Corporation
www.ohaus.com
7 Campus Drive
Suite 310
Parsippany, NY 07054 USA

Tel: 973-377-9000
Fax: 973-593-0359

In the United States call toll free, 800-526-0659 between 8:00 a.m. and 5:30 p.m. EST.

5.1 MB23 & MB25: HOUSING & INTERNAL PARTS

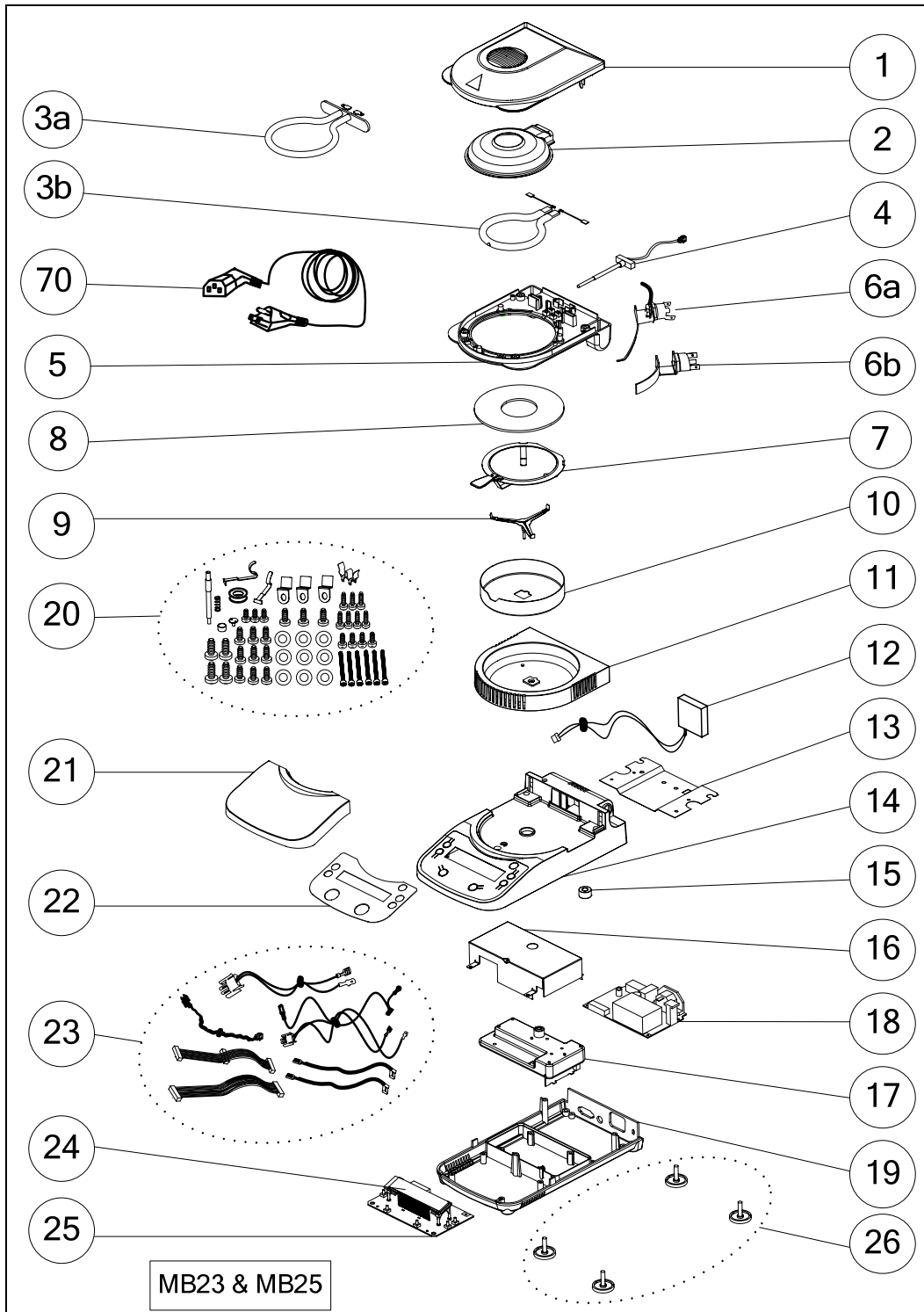

Figure 5-1. MB23 & MB25: Housing & Internal Parts.

5.1 MB23 & MB25: HOUSING & INTERNAL PARTS

TABLE 5-1. MB23 & MB25: HOUSING & INTERNAL PARTS

Drawing Item	Description
1	Top Housing Chamber
2	Reflector
3a	Heater, MB23
3b	Heater, MB25
4	Temperature Sensor
5	Heater Frame Housing
6a	Thermal Overload Device (MB23)
6b	Thermal Overload Device (MB25)
7	Protective Glass, MB25
8	Pan Handler
9	Pan Support
10	Draft Shield
11	Chamber Housing
12	Fan, with cables
13	Fan Plate
14	Top Housing
15	Leveling Bubble
16	Load Cell Cover
17	Load Cell
18	Power PCB
19	Bottom Housing
20	Hardware Kit
21	In-Use Cover
22	Function Label
23	Cable Set
24	LCD
25	Main PCB
70	AC Line Cord

APPENDIX A. CALIBRATION

A.1 WEIGHT CALIBRATION

Weight calibration is rarely required. Moisture analyzers use relative weight values to determine results, so a minor offset from the absolute weight has little effect on accuracy.

PREPARATION

- ✓ Ensure scale is level, stable, and undisturbed during calibration.
- ✓ Allow scale to warm up for five minutes after stabilizing to room temperature.
- ✓ Have a 50g calibration mass available.

Remove any load from the Pan, including the sample pan.

Note: To cancel calibration without saving changes, press:

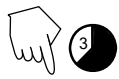

CAL



(Place weight on pan.)

50.000 g





(Clear pan.)

--0--



-done-

Analyzer returns to Weigh mode.

APPENDIX A STANDARD CALIBRATION

A.2 TEMPERATURE CALIBRATION

Use a Temperature Calibration Kit. (Available as an accessory.) If the analyzer has been recently used, allow at least 30 minutes before performing calibration.



Use *only* the OHAUS Temperature Calibration Kit. Using other methods could damage the Analyzer.

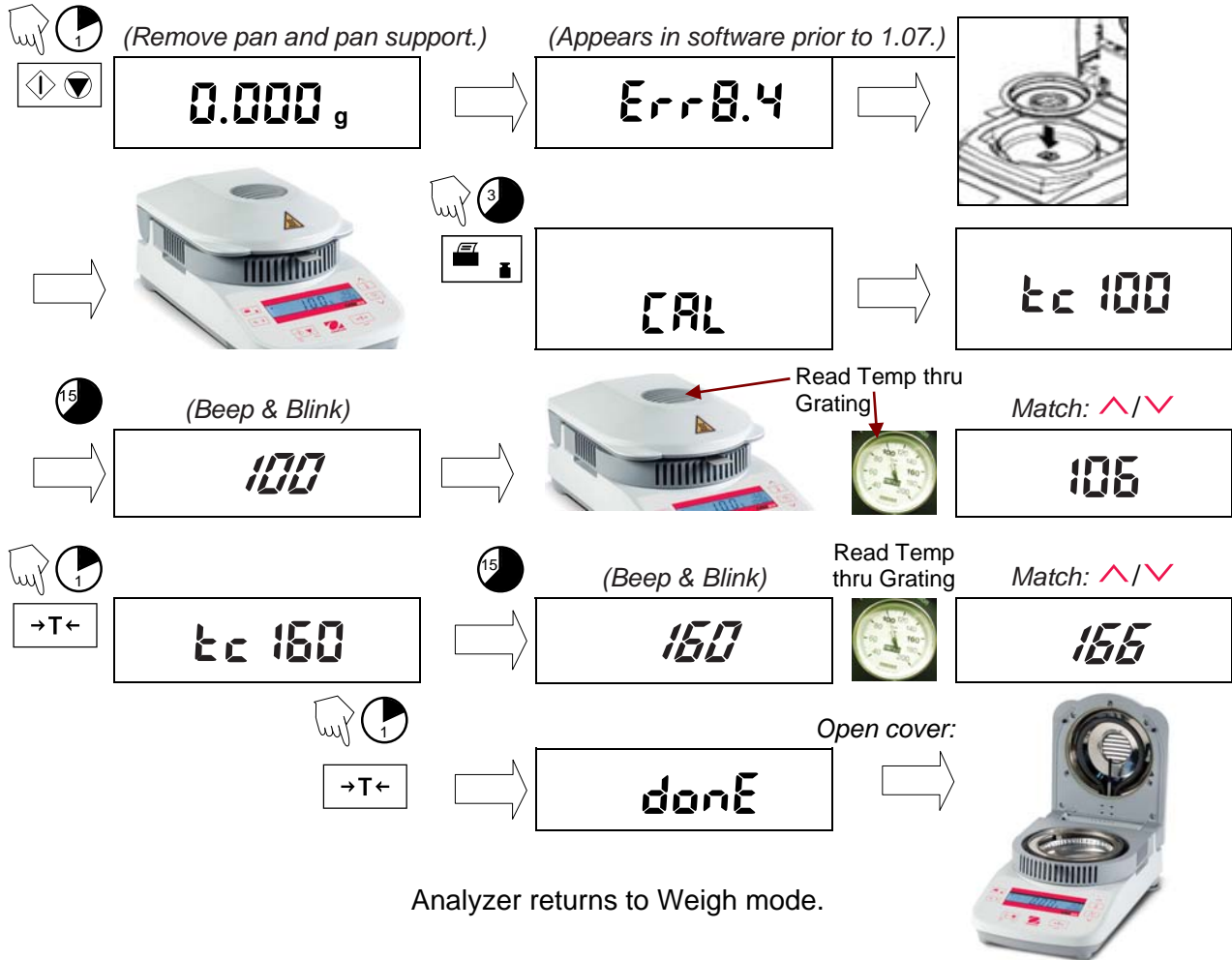

Allow Temperature Calibration Unit to cool before removing it.

APPENDIX B. SOFTWARE SERVICE TOOL INSTRUCTIONS

The Software Service Tool is used for five purposes:

1. To restore EEPROM data, after EEPROM corruption.
2. To install a new Load Cell.
3. To update the software in the Analyzer.
4. For diagnostics.
5. To perform Service Calibration.

Install the software on a Personal Computer running Microsoft Windows NT 4.0 or later. Insert the CD (or download the software) and run Setup.exe.

After installation, run the program Service Tool. The program has 5 tabs across the top of the screen. Click the tab for the function you wish to perform.

If the default settings for communication have been changed, click on settings and change the settings in the software to match.

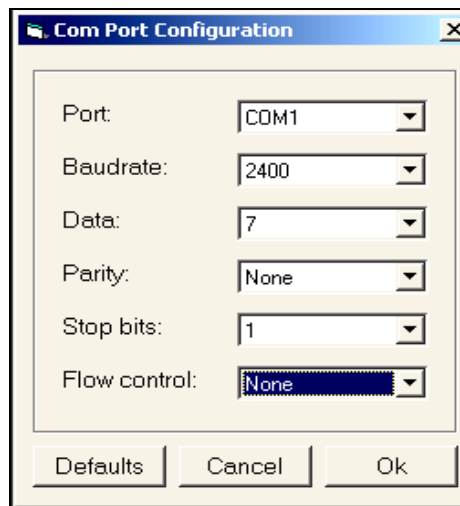

Figure B-1. Com Port Configuration Menu.

B.1 To Restore the EEPROM data:

1. Record the Serial Number and Model Number from the label on the bottom of the Analyzer to be repaired.
2. Contact Ohaus Corporation in Pine Brook NJ, and request the data file to download. Provide the information recorded above.
3. After receiving the data file from Ohaus, continue with the following steps.
4. Connect the Analyzer to the PC and start the Software Service Tool.
5. Click the tab labeled **Restore EEPROM**.

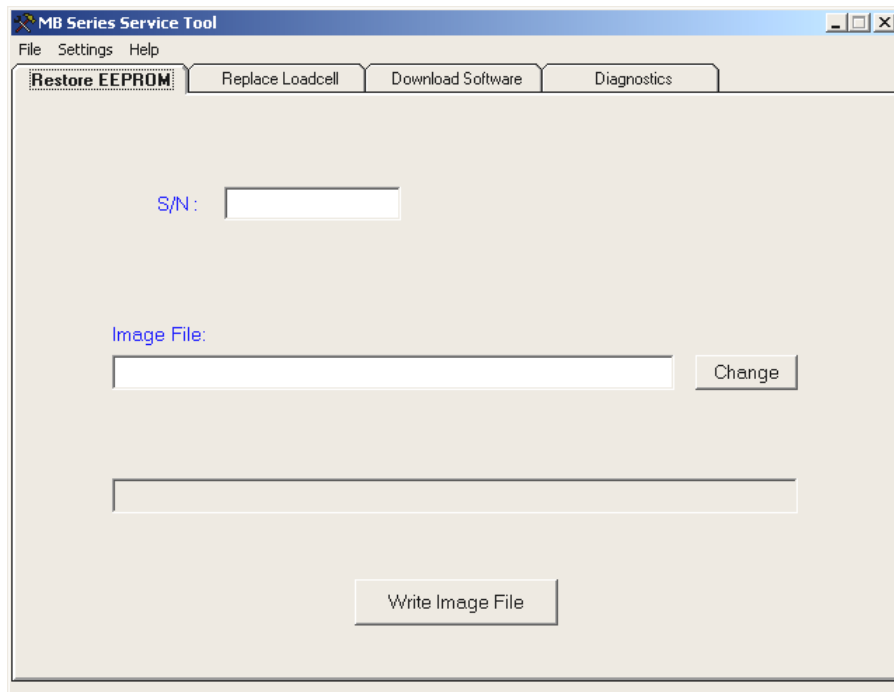

Figure B-2. The Software Service Tool's Restore EEPROM Tab.

6. Enter the Analyzer's Serial Number.
7. Enter the path to the image file, or click the **Change** button to locate the file.
8. Click the **Write Image File** button.
9. The software will indicate the download progress. When complete, disconnect the power from the back of the Analyzer, then re-connect.
10. Perform Service Calibrations (see Section B.5). Test the Analyzer.

B.2 To Replace a Load Cell:

1. Follow the steps in Section 3-2 to replace the defective load cell.
2. Connect the Analyzer to your computer.
3. Start the Software Service Tool Software.
4. Click on the tab labeled **Replace Loadcell**.

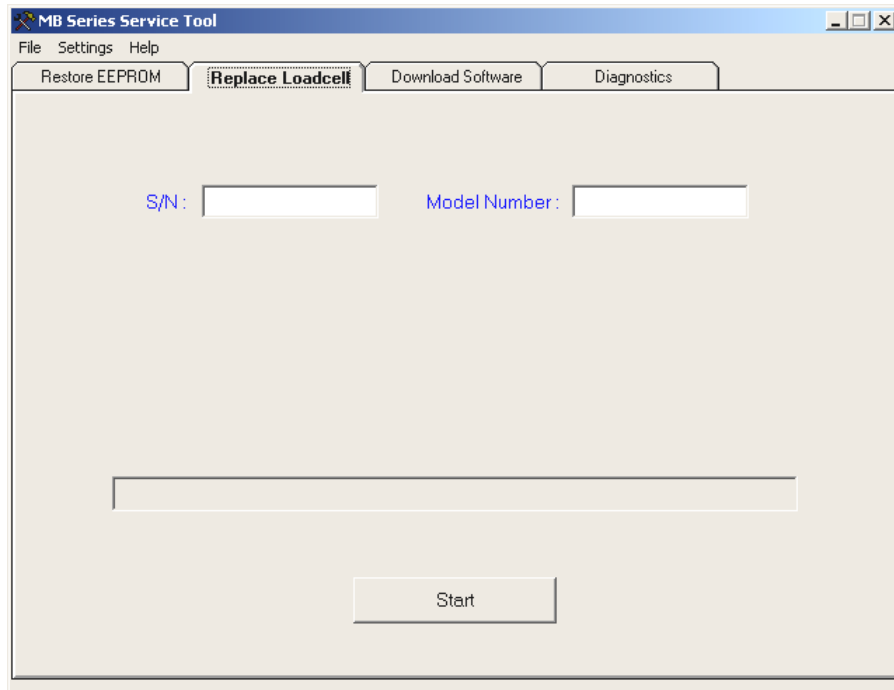

Figure B-3. The Software Service Tool's Replace Load Cell Tab.

5. Enter the Serial Number from the label on the bottom of the Analyzer.
6. Click the **Start** button.
7. The software will indicate the download progress. When complete, disconnect the power from the back of the Analyzer, then re-connect.
8. Perform Service Calibrations (see Section B.5). Test the Analyzer.

B.3 Update the Software in the Analyzer:

1. Connect the Analyzer to your computer.
2. Start the Software Service Tool Software.
3. Click on the tab labeled **Download Software**.

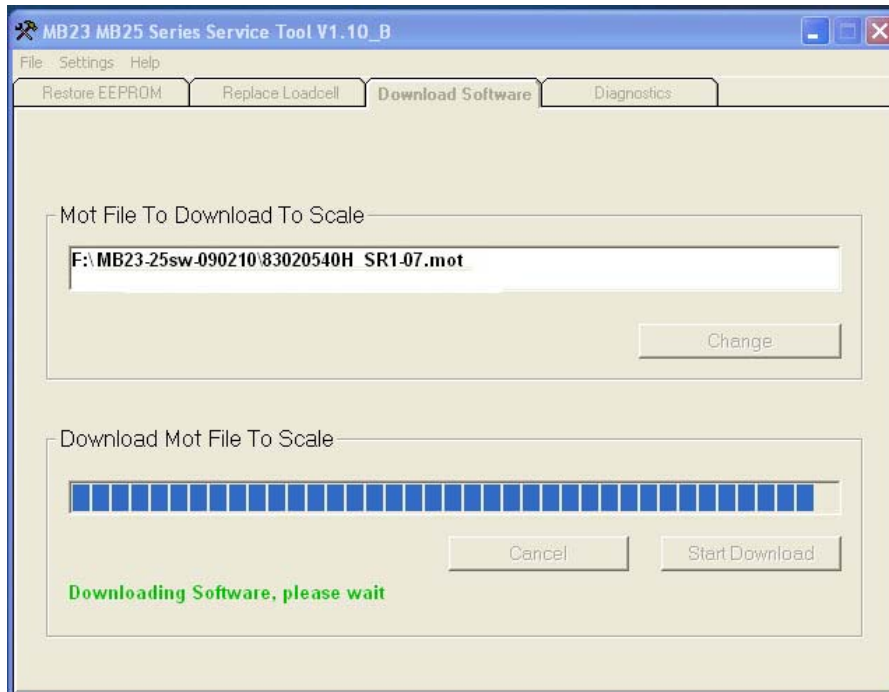

Figure B-4. The Software Service Tool's Download Software Tab.

4. Enter the path to the file to download, or click the **Change** button to locate the file.
5. Click the **Start Download** button.
6. When prompted, disconnect the power from the back of the Analyzer, then re-connect.
7. The software will indicate the download process. When complete, disconnect the power from the back of the Analyzer, then re-connect.
8. Perform Service Calibrations (see Section B.5). Test the Analyzer.

B.4 Diagnostics

1. Connect the Analyzer to your computer.
2. Start the Software Service Tool.
3. Click the tab labeled “**Diagnostics.**”

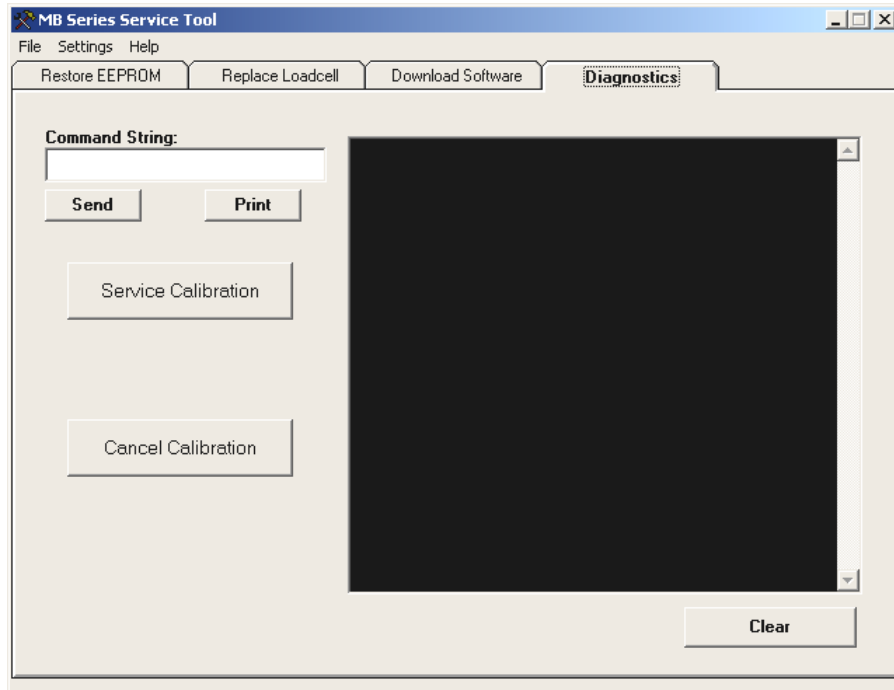

Figure B-5. The Software Service Tool’s Diagnostics Tab.

4. To test communications, click **Print**, or enter an RS232 Command String, and click **Send**.
5. The Analyzer’s response will be shown in the box on the right.

B.5 Perform Service Calibration

Note: This procedure requires a 50g calibration mass. (Available from Ohaus.)
(If a calibration mass is unavailable after calibration starts, click **Cancel Calibration**.)

1. Click the **Service Calibration** button.
(Click **Cancel Calibration** to stop the process.)
2. Place the 50g calibration mass on the platform when prompted.
3. Remove the mass when prompted.

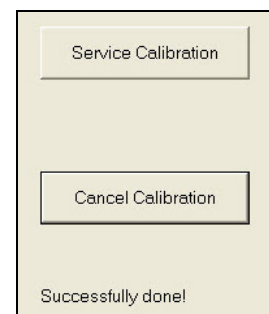

The Analyzer returns to weighing mode.

Note: Service Calibration is also possible without the Software Service Tool – see Appendix A.



* 8 0 2 5 2 4 6 9 *

P/N 80252469 A SERVICE MANUAL: MB23 & MB25 MOISTURE ANALYZERS