

Electronic Crane Scale CE User's Guide



CRANE SCALE OCS-TPS

Table of contents

1. Overview.....	2
2. Features & Specifications.....	2
3. Keypad Operation.....	3
4. General Scale Operations.....	4
5. Battery Charging.....	5
6. Precautions.....	5
7. Calibration Method.....	5
8. Sub-menu Function Setup.....	5
9. Displays	6
10. Schematics.....	7

Overview

The electronic crane scale combines reliable, advanced electrical hardware with good software. Using AT-89 series micro-processor and high speed, high precision A/D conversion technology, this series of scale has a specially designed jittering compensation circuitry so they can reach steady state quickly with strong anti-interference capability. This series of scales can be used for weighing application in commercial trade, mines, storage and transportations.

Specifications

Product Execute Standard	GB/T11883-2002
Accuracy Grade	III
Time to Stable Reading	<10 Seconds
Maximum Safe Load	150% Full Scale
Display Specifications	5-digit Super High Brightness 25 mm red LED display Or 5-digit 20 mm FSTN LCD display with back lighting
Hanging Fixture	360-degree swirl safe hook & shackle
Operating Temperature	-10°C ~ +40°C
Operating Humidity	30% ~ 90% RH
Low Voltage Indicator	Low voltage indicator turns on when the scale power supply voltage is low.
Power Supply	6V/3.2AH lead-acid rechargeable Battery (self contained)
Adaptor	Input: 100-240V output: DV 6V/800mA
Auto Power Off	30 minutes after the scale inactive or at extreme low power supply
Scale casing	Cast aluminum casing, corrosion safe, anti-static and light weight
Keypad	Light touch keypad



The keypad includes those keys such as division selection, Zero, Hold.

(Note: The above keys can be used in sub-menu to set up Kg-lb conversion, Beeper On/Off, Zeroing and indicator exchange, internal code displaying, etc.)

Max. Capacity (kg)	Mini. Weight (kg)	Measured Division	Selectable Division
500	5	0.2	0.1
1000	10	0.5	0.2
1500	10	0.5	0.2
2000	20	1.0	0.5

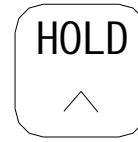
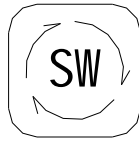
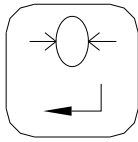
Keypad Function/Operation



1. [] : Press this key to set the current display to zero. Under weighing mode of operation to turn on/off the display backlighting (only applicable to LCD series)
2. [] : Press this key to change between Measured Division and Selectable Division.
3. [] : Press this key to keep the current display, the screen will flash. Press it again to quit this operation.

General Scale Operations

1. Turn On the Scale

Press the mechanical switch located on the back of scale to “1” position to turn on the scale. The scale’s maximum weighing capacity is first shown, and then the scale goes through a self-check sequence. After 0.0 is displayed and stable light is lit, the scale is ready for weighing operation. (Note: it is recommended to allow scale 3~5 minutes of warm-up time before starting weighing operation).

2. Zeroing

When the scale is switched on and with no load on the hook, press the  ZERO key to obtain the zero reading. .

3. Weight Measurement

Once the load is suspended completely, the display shows the weight value of the load. When the “Stable” indicator is lit, weight value can be recorded. In case there is tare such as cable, load the tare and press  to zero the display to “0”kg. The weight value after this will be the net weight. This weight change until the tare change or the scale being turned off.

4. Turn Off the Scale

After weighing operation, the scale should be turned off. Press the mechanical switch on the back of the scale to “0” position to shut off the power to the scale completely to prevent the leakage of the battery.

5. Division Conversion

Under weighing mode and the unit is ‘kg’, press key  to change between Measured Division and Selectable Division

Battery Charging Method

The scale uses maintenance-free 6V/3.2AH Lead-Acid battery. When scale is with low power, it will display the following signals:

- a When the low power indicator light  is lit. The scale needs to be charged now. However, the scale can continue to be operated for about 3 hours without charging.
- b. After the low power indicator is ON for several hours without charging or there is no more power in the battery, the crane scale will be powered off automatically. It will take about 5 hours to fully charge the battery.
- c. After battery charging, if there is no display, it indicates that either there is difficulty in battery charging or a damaged battery. Please contact supplier for repair or replacement.

d For Nickel – H battery, With a fully charged battery, the scale can be operated for about 30 hours. To prolong the battery life, please recharge the battery promptly using for every 20 hours of usage.

Scale Care









1. For weighing operation, please don't load the scale with weight load exceeding the maximum capacity.
2. Perform routine inspection and maintenance to ensure operation safety for these basic items:
 - a) Check for loose bolts.
 - b) Check hook and shackle for deformation, wearing and tearing.
 - c) Check other scale component for signs of metal fatigue.
 - d) Check for missing hook latch.

For the above problem, please stop using the scale and send it back to authorized dealer for repair or replacement of problem parts.

3. Do not touch the displaying screen directly.
- 4 .Do not use the scale in the rain or in a polluted environment.
5. Please remove the battery and store the scale in a dry environment if the scale is not going to be used for some time.





















Calibration Method

Please do not attempt to calibrate the scale without standard weight

Step	Operation	Display	Remarks
1	Press & Hold [] Key to power on	00000	Enter the calibration procedure, needed to enter password
2	Press [] Key to add Press [] Key to move the digit left	*****	Enter password
3	Press [] to confirm	SPAn	Scale should be with no load
2	Press [] Key	SEt 00000	Confirm zero point, when stable, display “00000”
3	Press [] Key to add Press [] Key to move the digit left	1500.00	Load the scale. The closer to full capacity the better. For example, 1500kg
4	Press [] Key	HOLd	To store the result once the weighing becomes stable
5	-----	1500.00	System goes back to weighing mode after several seconds.

Setup Functions in Sub-Menu

Step	Operation	Display	Remarks
1	Press [] key during the scale self-check sequence	00000	Enter the sub-menu, needed to enter password

	“9,...0” to enter the sub-menu		
2	Press [] Key to add Press [] Key to move the digit left	*****	Enter password
3	Press [] to confirm		Enter the alarm ON/Off setup mode. Press [] or [] key to toggle the digit. “0” is Off, “1” is “ON”
4	Press []	Hold 1	Hold valid/invalid setting Press [] or [] to change “ 0 ” is invalid, 1 is valid
5	Press []	Stb 0	Zero setting Press [] or [] to switch “ 0 ” can zero under any condition “ 1 ” can zero only obtain the steady reading
6	Press []	CHt 1	Units conversion between kg and lb Press [] or [] to switch “ 0 ” is lb, “ 1 ” is kg
7	Press [] Applicable to LCD series For LED series, please refer to the next step	Aut 0	Manual / AUTO backlight setup Press [] or [] to switch “ 0 ” is manual, “ 1 ” is auto
8	Press []	YES 0	Save or not Press [] or [] to

			switch " 0" is not to save, " 1" is to save
9	Press []		System will be restarted automatically

Displays

LED Display

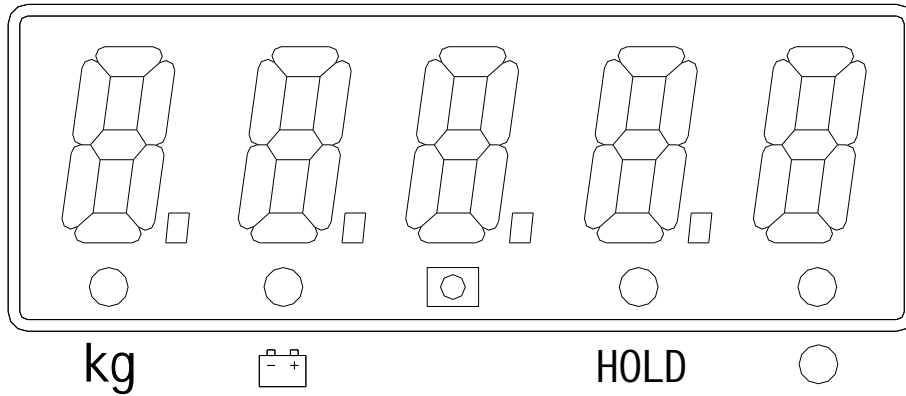

LCD Display

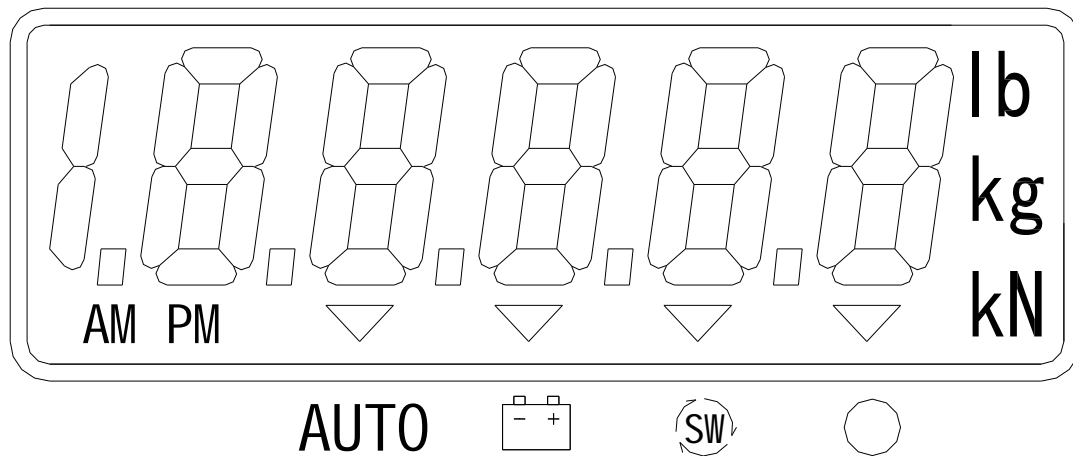

kg: Weighing in kg.

HOLD: The current weight is kept.

AUTO : Manual or Auto backlighting. When this symbol is lit, indicating the backlighting will be on during the weighing process.

 : 'Low Battery 'indication. When the lamp flashed, the battery needs to be charged.



'Division Conversion' indication. When this symbol is lit, indicating the display value is at selectable division status.



Stable indicator. When this symbol is lit, the weighing process is stable and customer can take record of the weight.

Schematics

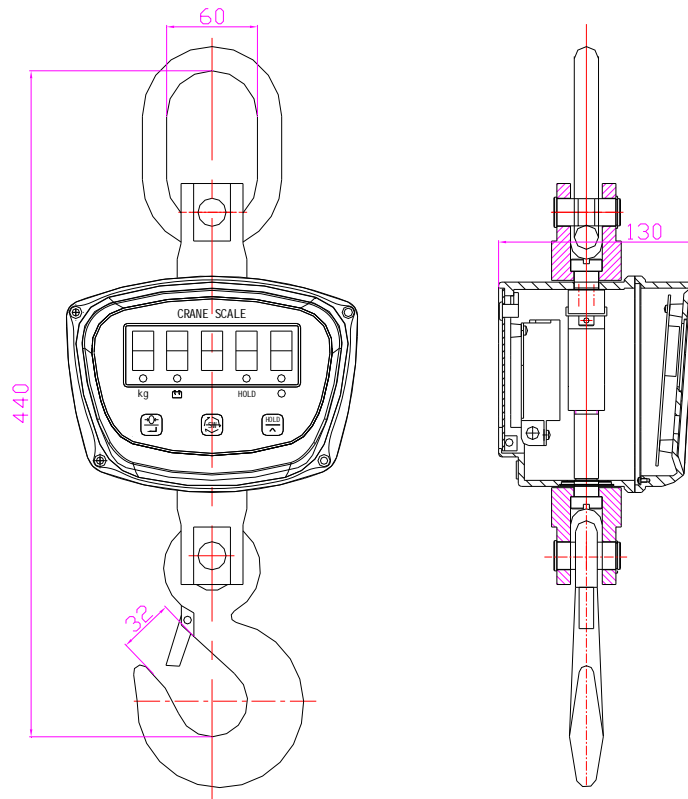

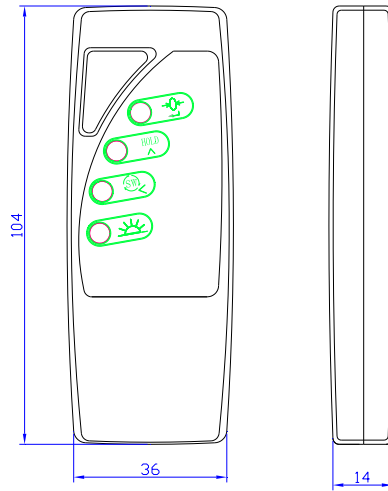

Nếu khách hàng cần sự giúp đỡ xin vui lòng liên hệ đường dây nóng

Người Nhận	Số Điện Thoại Liên Lạc
Hotline	(08)62.888.666 - (08) 62.999.111
Võ Hồ Thái Cường	0915.999.111
Tăng Văn Xa	0974.000.333
Tăng Thị Kim Cương	0908.444.000