



Professional Weighing Equipment **Operating Manual**

TB Series intelligent weighing machine

Touch Color Screen HIGH RESOLUTION

BALANCE



Introduction

What you should know about these Operating Instructions:

TB Professional Weighing Equipment products are simple to operate.

Nevertheless, you should read through these operating instructions in their entirety, so that you can make optimum use of the full potential and the diverse possibilities of the weighing machine in your daily work.

These operating instructions contain guidance with the aid of pictures and keyboard diagrams, which should help you in finding the required information:

For the labelling of potential hazards and advice, please see Safety below.

Contents

Section	Heading
1	Safety
	<ul style="list-style-type: none">- Representation and symbols- Safety recommendations
2	Your weighing machine
	<ul style="list-style-type: none">2.1 Construction and functions2.2 Application, conformity<ul style="list-style-type: none">2.2.1 Correct use of the weighing machine2.2.2 Conformity2.3 Data and parameters<ul style="list-style-type: none">2.3.1 Technical data2.3.2 RS232 Data Interface
3	Getting started with your weighing machine
	<ul style="list-style-type: none">3.1 Unpacking the equipment3.2 Scope of delivery3.3 Assembling your weighing machine3.4 Choice of a suitable location3.5 Checking the mains voltage3.6 Leveling the weighing machine3.7 Calibrating the weighing machine
4	Working with the application menu using the intelligent keypad
	<ul style="list-style-type: none">4.1 Display messages and key functions<ul style="list-style-type: none">4.1.1 Display messages4.1.2 Key functions4.2 Program options<ul style="list-style-type: none">4.2.1 Date and time Settings4.2.2 Display brightness Settings4.2.3 Interface Settings4.3 application options<ul style="list-style-type: none">4.3.1 Counting functions4.3.2 Percentage functions4.3.3 Density functions
5	Calibration using an external calibration weight
6	Maintenance and service
7	Transport and storage
	<ul style="list-style-type: none">7.1 Transportation and shipping7.2 Storage

1 Safety

1.1 Representations and symbols

Important instructions, which involve safety, are highlighted with the appropriate mark:



1.2 Safety recommendations

When using the weighing equipment in surroundings with increased safety requirements, the corresponding regulations must be observed.

The weighing machine may only be used with the power adapter supplied exclusively for use with the weighing machine.

Before inserting the power adapter, the user must ensure that the operating voltage stated on the power adapter agrees with the mains voltage.

If not, please contact Customer Service at the address above.

If the power adapter or its cable is damaged, the weighing machine must immediately be disconnected from the electricity supply (pull out the power adapter).

The weighing machine may only be operated from mains electricity supply with a power adapter which is in perfect condition.

If there should be any reason to believe that it is no longer possible to operate the weighing machine without danger, the weighing machine is to be immediately unplugged from the electricity supply (pull out power adapter) and secured against inadvertent operation.

In carrying out maintenance work, it is essential to follow the recommendations in Chapter 6 Maintenance and servicing.

The weighing machine must not be operated in an area subject to explosion risks.

Care must be taken when weighing liquids to ensure that no liquid is spilt into the inside of the weighing machine or into connections on the rear of the equipment or the power adapter. If liquid is spilt on the weighing machine, it must immediately be unplugged from the mains electricity supply (pull out power adapter).

The weighing machine may be operated after it has first been re-checked by a service technician.

These operating instructions must be read by each operator of the equipment and must be available at the workplace at all times.

2 Your weighing machine

The TB Series are high-quality electronic precision weighing machines with the following specifications

2.1 Construction and functions

Model number	Capacity	Graduation	Weighing pan Size
TB-123	120g	0.001g	Φ98mm
TB 213	210g	0.001g	Φ98mm
TB 313	310g	0.001g	Φ98mm
TB-1202	1200g	0.01g	Φ115mm
TB-2102	2100g	0.01g	195mm x 150mm
TB-3102	3100g	0.01g	195mm x 150mm
TB-6101	6100g	0.1g	195mm x 150mm
Net/gross weight	TB-123 / 213 / 313 / 1202: 2.kg / 2.9kg TB 2102 / TSC 3102: 1.6.kg / 2.4kg TB- 3101 / 6101 / 10001: 1.6kg / 2.4kg		
Package (Standard carton)	TB- 123 / 213 / 313: 34 x 27 x20(cm ³) TB-1002: 34 x 27x20 (cm ³) TB-3102/ 3101 / 6101 / 10001: 34 x 26 x13 (cm ³)		
Package (Master carton)	TB- 123 / 213 / 313 / 1202: 4 units in one box: 57x36x44 (cm ³) TB- 3102 / 3101 / 6101 / 10001: 6 units in one box: 55x36x44 (cm ³)		
Operating Temp.	0-40°C (32-104°F)		
Power source	Rechargeable batteries or AC/DC Adapter 12V/1000mA		

FEATURES

- Show date and time
- Auto zero tracking
- Low battery indication
- Color Capacitive touch Screen
- Large stainless steel pan
- Stability indication
- Auto calibration
- back light display brightness (adjustable)
- Less than 1s display setting time
- Percentage functions
- capacity indicator bar
- Selectable beeper
- Unit switching: g, oz, lb, dwtr
- 1.3 million internal resolution
- 200,000 display resolution
- 24 bit A/D processor
- Highest quality sensor used
- Counting functions
- Density functions

Figure 2.1 Details of your weighing

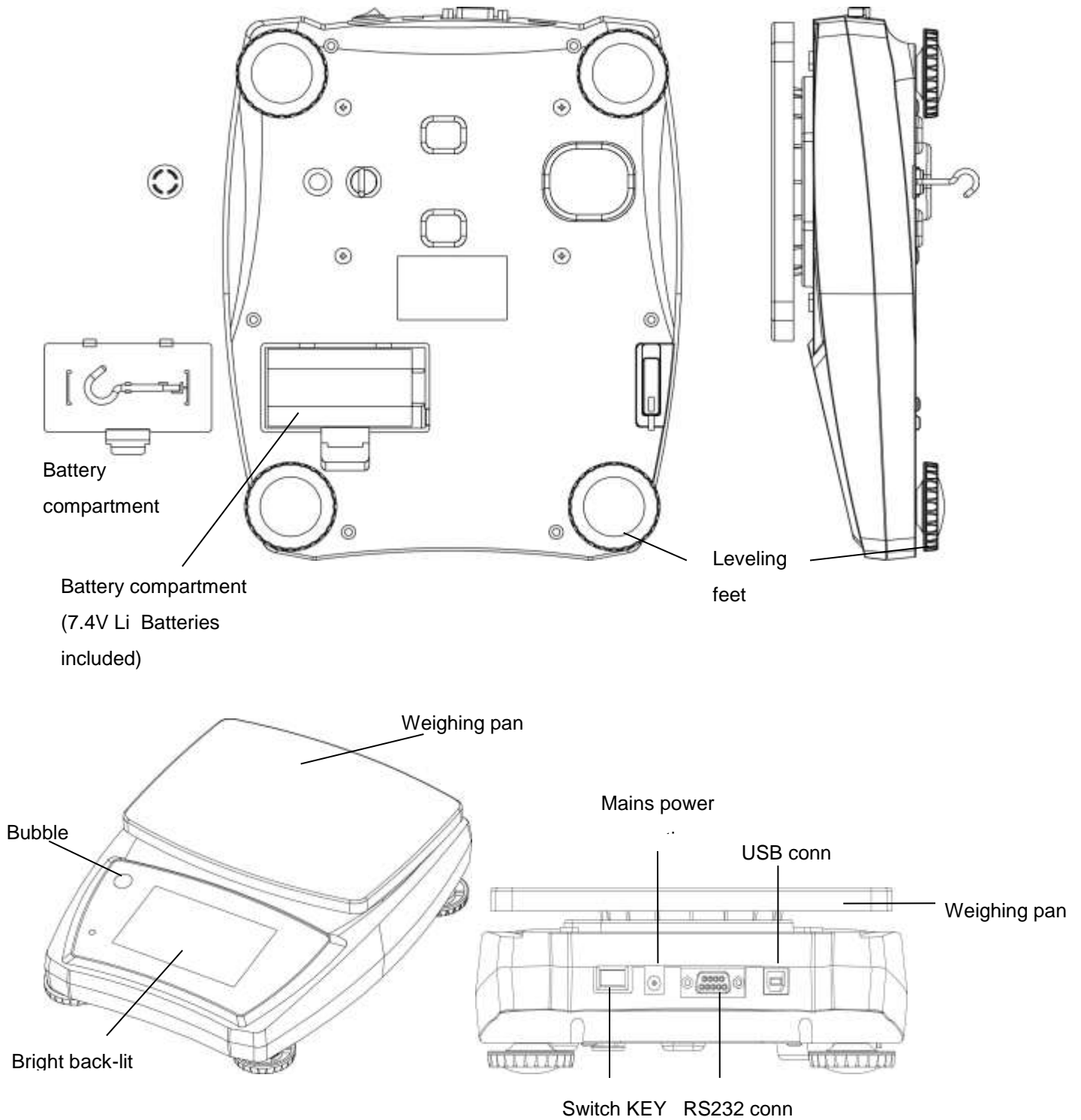

2.2 Application, conformity

2.2.1 Correct use of the weighing machine

The weighing machine may only be used for the weighing of solid-materials and of liquids filled into secure containers.

The maximum allowable load of the weighing machine must never be exceeded, otherwise the weighing machine may be damaged.

In using the weighing machine in combination with other appliances as well as with appliances produced by other manufacturers, the appropriate regulations for the safe use of the relevant attachments and their application in accordance with instructions must be observed.

2.2.2 Conformity

The weighing machine has been manufactured and tested in accordance with the standards and recommendations set out in the declaration of conformity.

The power adapter produced for the operation of the weighing machine and intended exclusively for this application, complies with the appropriate electrical protection class.

2.3 Data and parameters

2.3.1 Technical data

The following applies to TSC series

Power supply:

. Input: 110 or 230V AC (+/-15-20%); 50 to 60Hz

. Output: 12v DC 1A

Allowable ambient conditions

Temperature: 5°C - 40°C

Relative humidity: 25%... 85%, non-condensing

If you have any questions on the technical data or require detailed technical information on your balance, please contact your technical representative.

3 Getting started with your weighing machine

3.1 Unpacking the equipment

The machine is delivered in an environmentally-friendly carton, specifically developed for this precision instrument, which provides optimum protection for the balance during transportation.

We suggest that you retain the original packaging in order to avoid transportation damage if shipping or transporting the balance and to allow the unit to be stored in the best conditions if it is out of operation for an extended period.

In order to avoid damage, attention must be given to the following points when unpacking the balance:

Unpack the weighing machine carefully. It is a precision instrument.

When outside temperatures are very low, the balance should first be stored for some hours in the unopened transport package in a dry room at normal temperature, so that no condensation settles on the unit when unpacking.

Check the weighing machine immediately after unpacking for externally visible damage. If you should find transport damage, please inform your service representative immediately.

If the unit is not to be used immediately after purchase but only at a later time, it should be stored in a dry place where fluctuations in temperature are as low as possible (see Chapter 12 .Transport, storage.).

Read through these operating instructions, even if you already have prior experience with weighing equipment, before you work with the unit and pay attention to the Safety recommendations (see Chapter 1 .Safety).

3.2 Scope of delivery

Inspect delivery for completeness immediately on unpacking all components.

Checklist for complete delivery

	Component delivered present yes / no
Weighing unit body	
Weighing pan	
Power adapter	
Operating manual	

3.3 Assembling your weighing machine

The weighing machine is delivered in partly dismantled condition. Assemble the individual components in the following sequence:

- Place the unit holder in position and add the weighing pan
- Insert the power adapter cable plug into the socket at the rear of the balance.

3.4 Choice of a suitable location

The environment in which your weighing machine is used is very important. Air movement, temperature changes, vibrations, direct sunlight, etc. all influence the performance of high precision weighing machines. Therefore, place your weighing machine on a solid, sturdy surface that is free of air currents, vibration and not in direct sunlight. The surface should not be magnetic and should be located away from doors, windows, heaters, air conditioners and fans.

To summarize:

- Put the weighing machine on a solid, firm and preferably vibration-proof, horizontal base
- Make sure that the weighing machine cannot be shaken or knocked over
- Protect from direct solar radiation
- Avoid drafts and excessive temperature fluctuations

3.5 Checking the mains voltage

The following Safety recommendations must be observed when connecting the balance to the mains:



The balance may only be operated with the power adapter supplied.

Check before connecting the power adapter to the mains supply, that the operating voltage stated on the power adapter agrees with the local mains voltage.

If the operating voltage is not the same as the mains voltage, the power adapter must on no account be connected to the mains supply. Contact customer service.

3.6 Leveling the weighing machine

To function properly, the balance must be precisely horizontal. The balance is fitted with one bubble level and adjustable feet for level-control, with the aid of which it is possible to compensate for small height differences and / or any unevenness in the surface on which the balance is positioned.

The screw feet must be adjusted so that the air bubble is precisely in the center of the sight glass of the bubble level (see Fig. 3.2)

Place the scale horizontally and keep the bubble inside the bubble level aligned with the red circle (See Fig.3.2). In order to get exact measurements, the balance must again be carefully leveled after each relocation.



Fig. 3.2 Correct leveling with the aid of the bubble level

3.7 Calibration of the weighing machine

Since the effect of the Earth's gravity is not the same everywhere every balance must be adjusted to compensate for the gravity differences at each location in accordance with the underlying physical weighing principles which apply to accurate weighing machines. This adjustment process is known as calibration and must be carried out on initial installation, regularly in accordance with internal quality systems and after each subsequent relocation.

In order to ensure best measurement results it is recommended that the balance should be calibrated regularly and often using a known external calibration weight (see Section 5 below).

4 Working with the application menu using the Intelligent Key-Pad

4.1 Display messages and key functions

4.1.1 Display messages:



4.1.2 Key Functions:

1. The On/Off key is to turn the Balance On or Off (Note: It is a hard switch on/off on the right rear)
2. The ZERO key allows the subtraction of multiple container values through the weighing range and is used to set or re-adjust the weighing machine in correct zero position.
3. The TARE allows the user to subtract the container value and returns the display to zero
4. The Print key is send data to external device through RS232 to USB connector.
5. The Weighing units key is to toggle between different weighing units. Press Weighing unit , the display will show

< Unit					
	g	oz	lb	dwt	
	ozt	ct	tl.T	tl.H	
	tl.J	GN	dr	MM	
	tola	gsm	T/A/R	T/M/R	

Click on the required units.

4.2 Program options

Press [ON/OFF] to turn on the scale,
when instrument displays



Press , the display will show

Press , the display will show

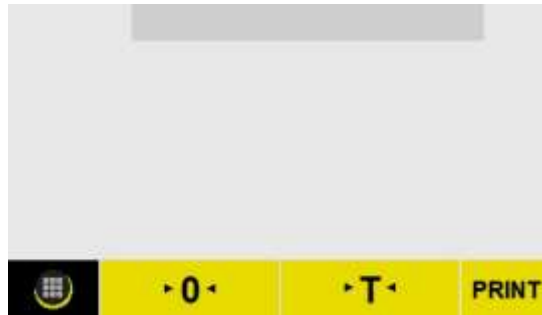

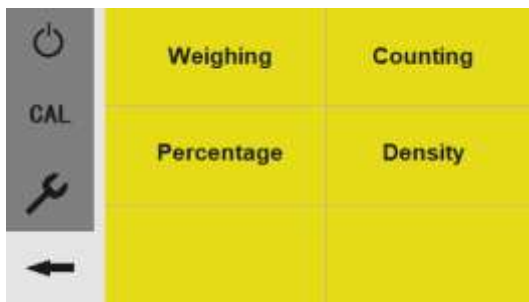

Press , the display will show

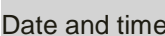

4.2.1 Date and time Settings

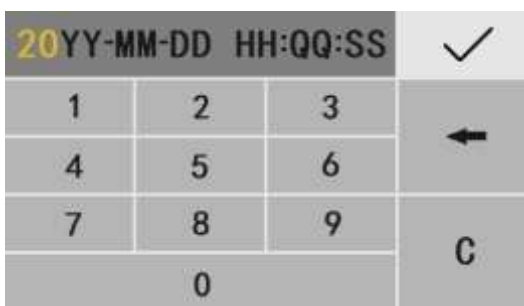
Press , the display will show



Press numbers key input date and time, press  .

4.2.2 Display brightness Settings

Press **Display brightness**, the display will show



Press **CHANGE** to select: Medium/Slight/Bright, press ✓.

4.2.3 Interface Settings

Press **Interface**, the display will show

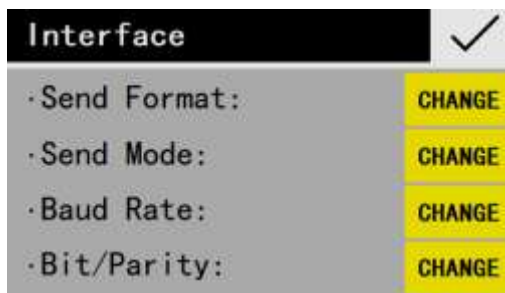

Press **CHANGE** to select:

send Format: PM / FT, default setting is PM

send Mode: Key/Stb / Con /OFF, default setting is Stb

- a) OFF stands for serial data output disabled
- b) Key stands for manual mode by pressing [PRINT]
- c) STB stands for automatic print when scale is stable
- d) CON stands for continuous print

Baud Rate: 1200/2400/4800/9600, default setting is 9600

Bit/parity: 8,N,1/7,O,1/7,E,1, default setting is 8,N,1.

(7,O,1 stands for 7 data bits with odd parity, 7,E,1 stands for 7 data bits with even parity, 8,N,1 stands for 8 data bit without parity)

Press ✓. again to return to Setting mode.

Press **<**, Press **←** again to return to Weighing mode

4.3 Application options

Press [ON/OFF] to turn on the scale, when instrument displays



Press ✓, the display will show

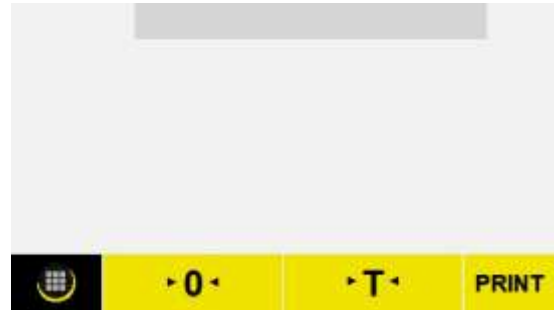

Press , the display will show



4.3.1 Counting functions

Press **Counting**, the display will show

Place the container on the balance then press T to tare. Press , the display will show

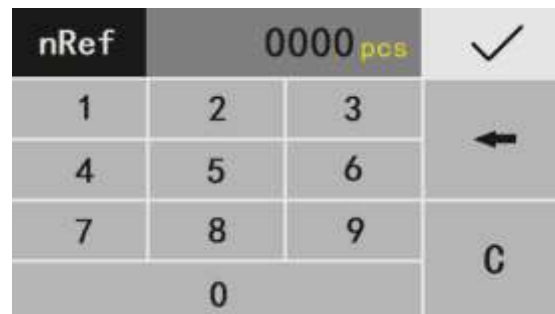

Input sample reference number, place the input number of sample into the container, then press ✓, the display will show



Press **START** again, display shows the reference sample number which you input
Place full amount of sample in the container, display shows the quantity of sample



4.3.2 Percentage functions

Press **Percentage**, the display will show

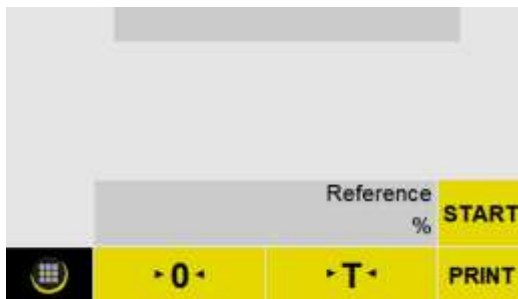

Press **Reference %**, the display will show

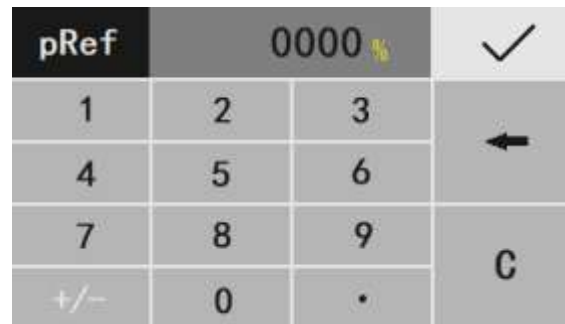

Input the percentage of reference sample, place sample on the container, then press ✓,



Press **START** again, display shows the percentage of reference sample. Place full amount of sample on the container, display shows the percentage of sample

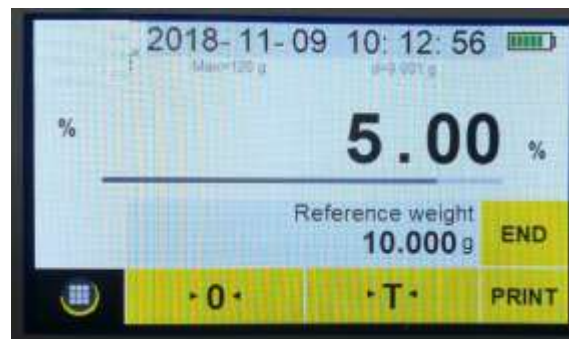

4.3.3 Density functions

Full set of density measure is necessary to realize this function

Press **Density** , the display will show

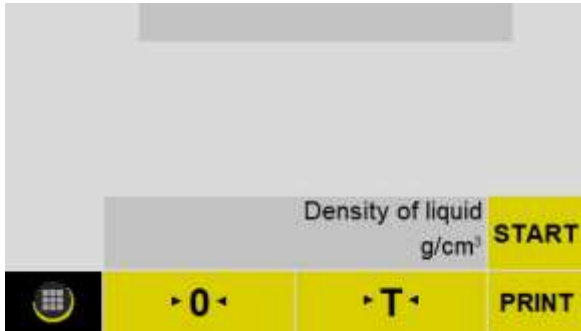

Press **Density of liquid g/cm³** , the display will show

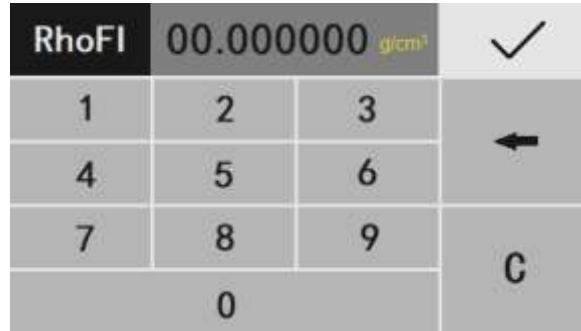

Input medium liquid density then press \checkmark .
Remove the tare weight of the scale in the next display and make the scale return to zero, then press **START**

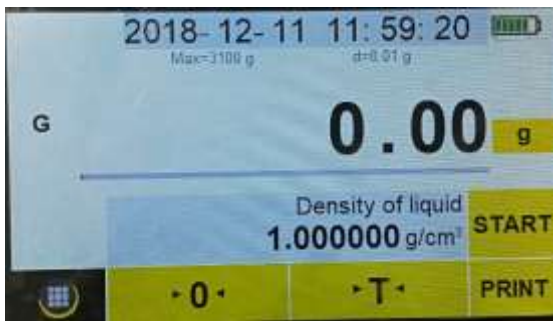

Place sample on the upper square platform of density measure



To check its weight in the air, press \square ,

display show



Immerse your sample on the structure in the liquid

beaker and then press \square , Display shows the density of solid sample.



5 Calibration Using an External Calibration Weight

Calibration is required when the weighing machine is initially installed or if the balance is moved to a substantial distance from the original location or if ambient conditions change considerably. 30 minutes' warm-up of the balance is always needed before weighing and calibration.

Press [ON/OFF] to turn on the scale,
when instrument displays

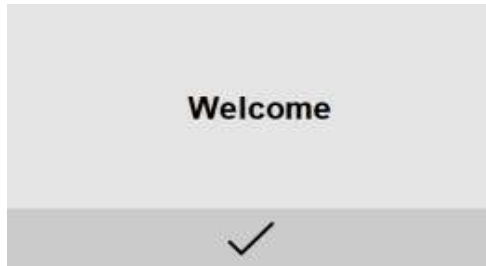

Press ✓, the display will show

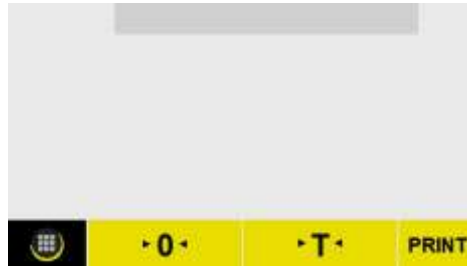

Press , the display will show



Press CAL, the display will show

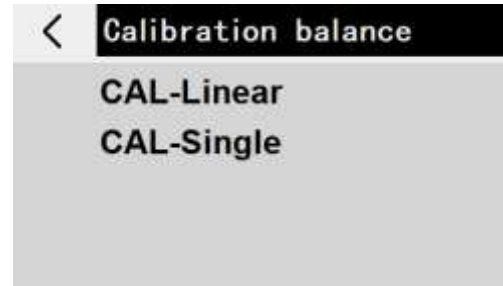

Press CAL-Single, the display will show

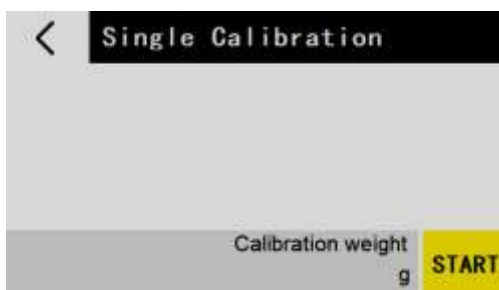

press Calibration weight key, the display will show

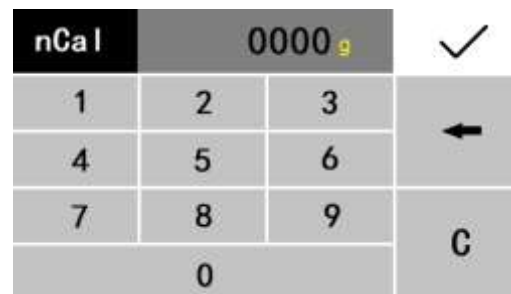

- Press numbers key input digit (calibration weight can be set according to users' requirements, we recommend a minimum weight of at least 50% of the Balance capacity)
- Press ✓, the display will show

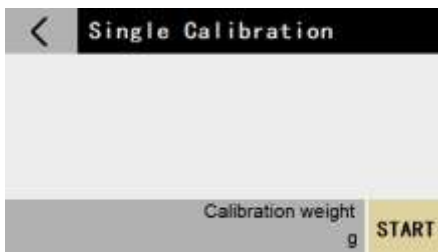

- Press **START** key, the display will show a series of digits known as the A/D value, press **START** key again ,the display will show the flashing calibration weight.
-
- Place the corresponding test weight on the center of the pan
-
- Wait for the stable indicator displayed the display will return to weighing mode
-
- Now the calibration is completed
-
- place a known weight on the platform to verify if it is accurate.
-
- If the weight displayed does not correspond with the value of the calibration weight, please repeat above steps.

6 Maintenance and service

The weighing machine must be treated carefully and cleaned regularly. It is a precision instrument.



For maintenance-work, the balance must be separated from the power supply (remove power adapter plug from socket). Also ensure that the balance cannot be reconnected to the power supply during the work by a third party.

Take care during cleaning that no liquid penetrates into the appliance. If liquid is spilt on the balance, the latter must immediately be disconnected from the electricity supply. The balance may only be used again after it has first been checked by a service engineer.

The connections on the rear of the appliance and the power adapter may not come into contact with liquids.

Regularly dismantle the weighing pan and the weighing pan holder and remove any dirt or dust from under the weighing pan and on the weighing machine housing with a soft brush or a soft, lint-free cloth, moistened with a mild soap solution. The scale and the holder can be cleaned under running water. Take care that both parts are completely dry before they are re-installed on the scale.

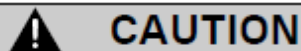

Never use solvents, acids, alkalis, paint thinners, scouring powders or other aggressive or corrosive chemicals for cleaning, since these substances attack the surfaces of the scale housing and can cause damage.

7 Transport, storage

7.1 Transportation and shipping of the weighing machine

Your weighing machine is a precision instrument. Treat it carefully. Avoid shaking, severe impacts and vibration during the transportation.

Take care that there are no marked temperature fluctuations during the transportation and that the weighing machine does not become damp (condensation).

7.2 Storage of the weighing machine

If you would like to take the weighing machine out of service for an extended period, disconnect it from the electricity supply, clean it thoroughly (see Section 6 .Maintenance and servicing.) and store it in a place which meets the following conditions:

- No violent shaking, no vibrations
- Minimum temperature fluctuations
- No direct solar radiation
- Minimum moisture

The weighing machine should preferably be dispatched and transported in the original packaging to avoid transportation damage.

The weighing machine should preferably be stored in the original packaging, since this provides optimal protection for the weighing machine.

8 TB Series Conversions Of Various International Weight Units

Model UNIT Resolution	123	213	313	1202	2102 3102	6101 10001
g	0.001g	0.001g	0.001g	0.01g	0.01	0.1g
oz	0.00005	0.00005	0.00005	0.0005	0.0005	0.005
lb	0.000002	0.000002	0.000002	0.00002	0.00002	0.0002
dwt	0.001	0.001	0.001	0.01	0.01	0.1
ozt	0.00005	0.00005	0.00005	0.0005	0.0005	0.005
ct	0.005	0.005	0.005	0.05	0.05	0.5
tlT	0.00005	0.00005	0.00005	0.0005	0.0005	0.005
tlH	0.00005	0.00005	0.00005	0.0005	0.0005	0.005
tlJ	0.00005	0.00005	0.00005	0.0005	0.0005	0.005
gn	0.02	0.02	0.02	0.2	0.2	2
dr	0.001	0.001	0.001	0.01	0.01	0.1
MM	0.0005	0.0005	0.0005	0.005	0.005	0.05
tola	0.0001	0.0001	0.0001	0.001	0.001	0.01
gsm	0.1	0.1	0.1	1	1	10
T/A/R	0.01	0.01	0.01	0.1	0.1	1
T/M/R	0.01	0.01	0.01	0.1	0.1	1