

ShangHai DB Scale Co.,Ltd

Label Printing Scale

Original : January 2017

(Revised)

DSR-100PE Series

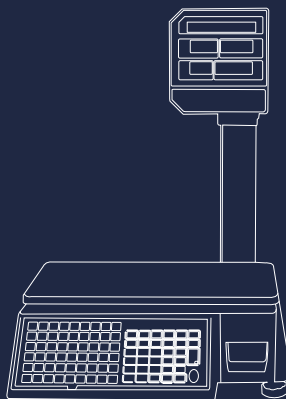

Thank you for using our product of our company. In order for you to use the product correctly and avoid unnecessary trouble in the future, please read this manual carefully before use!

Attention!

1. Before installing please ensure to check if the power requirement on the nameplate is match with the power you are about to use in order to avoid damaging the machine.
2. Please confirm if the power grounding cable is connected properly in accordance with requirements of usual electrical safety.
3. Please do not put body weight on the scale to avoid damaging the weighing sensor.
4. Please do not beat or strike strongly the load tray of the scale to avoid damaging the weighing sensor.
5. Please do not soak the scale body in the water to wash, do not use a dripping cloth to scrub the machine to avoid causing damage to the machine.
6. When the machine is moved to a place of higher temperature from a place of lower temperature where with big temperature difference, please do not switch on power immediately for fear that coagulation of moisture causes damage to the machine.
7. Thermal printing head or backup battery (optional) is not covered by warranty, please use and maintain it in accordance with product specification or recommendations of our maintenance staff.
8. Contact your local distributor if you have any questions, or call: +86-21-5975-7333 to inquire Technical Services Department of Shanghai Shanghai DB Scale.

Please carefully read all the contents of the manual before use, so as to ensure safe and effective use of product, please keep the user manual properly after use for review in the next use.

Statement

For improvement or renewal of the product, we reserve the right to modify the document at any time without notice. Do not disassemble the equipment or damage the seal, otherwise we would not bear the responsibility of the warranty and replacement of equipment.

Statement

For the trademark covered by this manual, Shanghai DB Scale Co., LTD. enjoys trademark right and receives protection under law

Contents

I .Overview	
1.1 Appearance and structure	4
1.2 Specifications	7
1.3 Features description of keyboard and key	9
II.Paper Load, Poling and Fixing of Display Module and Horizontal Adjustment	12
2.1 Paper loading.....	12
2.2 Poling installation of display module.....	13
2.3 Horizontal adjustment.....	14
III.Basic Operation	14
3.1 Preparation before use	14
3.2 Power on/power off/charge	15
IV.Setup of System Function (SPEC LIST) and Allocation of Function (FUNCTION KEY)	17
4.1 List of settings of user functions (SPEC 141)	17
4.2 Operation of settings of user functions (SPEC 141)	29
4.3 List of distribution of function key (FUNCTION KEY LIST)	29
4.4 Operation of distribution of function key	31
4.5 Communication settings (settings for local area network and WIFI)	32
4.6. Operation instance of settings of wired network IP address:H03 (for example IP address is 192.168.0.16)	36
4.7. Operation instance of settings of IP address and AP of wireless WIFI network card (H11)	37
V.System Calibration, Basic Parameter Settings and Operation Instance	38
5.1 Weight calibration.	38
5.2 Edit of date and time	39
5.3 Edit of visibility of commodity	39
5.4 Edit of commodity and distribution of shortcut key	43
5.5 Print transaction receipt	46
5.6 Operation of promotion	53
5.7 Cancellation operation of transaction	53
5.8 Printing of statement	55
VI.Data Clear and Data Maintenance Mode (Z mode)	60
6.1 Operation instance and instruction of data clear (Z mode)	60
6.2 Operation instance and instruction of data maintenance (Z mode)	62
VII.Operation Instances	68
7.1. Operation instances of user function settings(SPEC-141).....	68
7.2. When there is no product information (no PLU), how to realize that input unit price only to print receipt(Replace SP060=0 with Sp060=(refer to following operation)	68
7.3 When there is product information, how to realize that input unit price only to print receipt.....	70
7.4 How to realize printing of information at letterhead of receipt paper (maximum 5 lines).....	72
7.5 How to realize printing of information at paper footing of receipt paper (maximum 6 lines).....	73

7.6. How to realize that round up subtotal price on transaction receipt to ten-cent.....	73
7.7. How to realize that round up total price on transaction receipt to ten-cent.....	74
7.8. How to modify printing of minimum weight value to achieve printing upon weight.....	75
7.9 How to realize printing of multiple copies of receipts.....	76
7.10. How to realize reprinting of ticket.....	77
7.11. How to realize sales return.....	78
VIII.The Error Message Table.....	79

I. Overview

1.1 Appearance and structure

- BE type (monochrome LED)

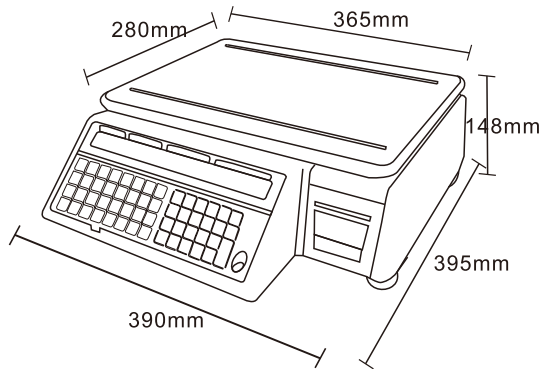

- PE type (monochrome LED)

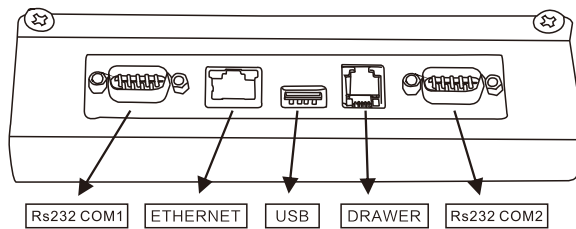
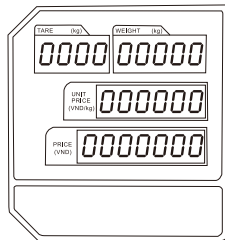
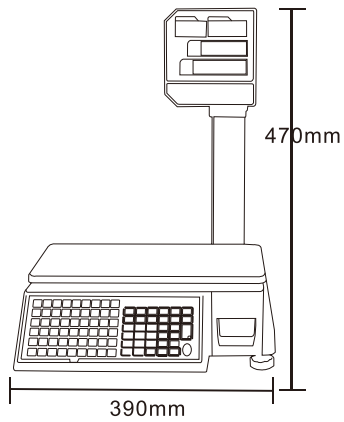

● PC type

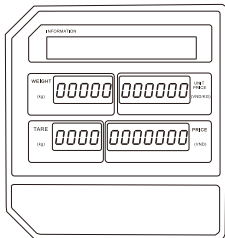
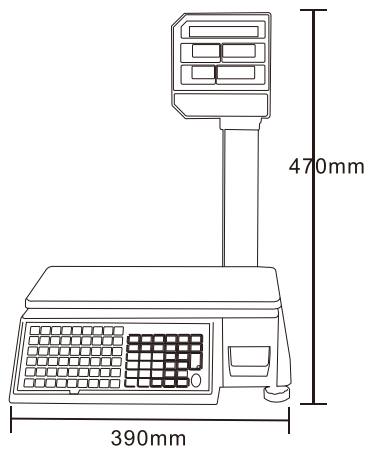

1.2 Specifications

●Basic Specifications

Maximum weighing range minimum load weighing division value verification	15Kg (6Kg/15Kg) 30Kg (15Kg /30Kg) 40g 100g 2g/5g 5g/10g
Display resolution	Display resolution 1/3,000 can be set to double-range(1/6,000 or 1/7500)
Internal resolution	1/60,000
Tare range:	Under single-range mode
	0.001~1.499 Kg(3Kg) , 0.002~2.998 Kg(6Kg), 0.005~7.495 Kg(15Kg) , 0.010~9.990 Kg(30Kg)
	Under double-range mode 0.001~2.999 Kg(6Kg) , 0.002~7.498 Kg(15Kg) 0.005 ~ 9.995 Kg (30Kg)

Accuracy grade:	Ⅲ Grade
0-point tracking range:	It can be set (2%fs, 4%fs, 10%fs)
Nonlinear error:	0.016% FS
Power supply:	AC: 220v- 15%~10% Frequency:50Hz/60Hz
Working temperature:	0℃ ~ + 40℃
Table size:	365mm X 280mm
Display mode:	LED or field LCD+ dot matrix LCD (it can be displayed in Chinese characters and western characters)
Key form:	Membrane keyboard
Number of shortcut key:	144 pcs. (three tiers)
Printing speed:	70mm/s
Type of printing:	Thermal printing, receipt printing. Automatic printing or manual printing can be chosen
Printing content:	Supports for weighing information and traceable code printing and rotation of linear bar code and QR code. Able to print cashier ticket, cumulative receipts and statistic list.
Print media:	Thermal sensitive receipt paper, width of paper: 56mm , diameter of roll of paper: max=60mm.
Installation method of printing paper:	Printing paper bin, easy to install.

	single-sided 22-bit)	Chinese characters and western characters can be shown	
Printer		Thermal printer, paper type receipt paper, paper width 56mm max paper speed 70mm/ second	
Built-in card reader	Optional	Optional	Diameter of roll of paper max 60 mm
Built-in clock	Possession	Possession	Readable S50, S70, CPU
Commodity PLU	2000 lines	2000 lines	
Transaction data record	1000 lines	1000 lines	
Settlement of statement function	Yes	Yes	
Printing of statement function	Yes	Yes	
Periodic discounts and allowance	Yes	Yes	Can be equipped with purchase-sell-stock background software

●Data communication and control output interface

Standard configuration of the host machine is with wired network interface (Ethernet), wireless network interface WIFI and 3G network (optional), standard USB interface, serial interface a COM1,(RS-232 three-wire mode, with power output 5V300mA, and universal cash box control interface (uses RJ11-6PIN connector, and PIN2 and PIN4), which can be directly connected to the 8Vuniversal cash box.

Upgrades of system software for electronic scale, settings of remote functions (using XDBManager software), configuration of application data and data transfer(download and recycle of PLU data, upload of SDB transaction data and download of traceability information) can be realized via a wired network interface (Ethernet) or wireless network interface (WIFI,3G).

Standard USB interface allows you to connect to universal USB disk. Upgrade of system software of electronic scale and initialize settings of system function can be realized by using USB disk.

The serial interface COM1 can connect to an external RFID card reader, such as card reader of UnionPay debit card. Realizing electronic payment of transaction or connect with the external serial bar code scanner gun.

Recognize information and prices of packaged items by the bar code scanning gun to achieve creation of transaction of non weighing commodity and transaction record and printing of receipt

●Printing of label, receipt and ticket

Using high-speed and high reliability thermal sensitive printing head. Specially designed printing mechanism for easy installation of printing paper. Maximum printing speed is 70mm/s, valid printing width is 48mm, width of printing paper is 56mm, the maximum diameter of the roll of paper is 60mm.

Can print transaction receipt, settlement statement, system setup data, configuration information, bar code and QR code, with 5levels of printing concentration settings and intelligent print speed optimization.



Supports for linear bar code and RQ code printing, bar code type of EAN8, EAN13, CODE128, QR two-dimensional code can be chosen.

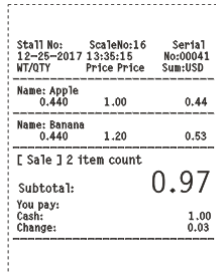

Actual sample of printing bill

Double-sided display for customer and operator, selectable display modes are dot matrix LCD or monochrome LED (red 0.56 inch or green 0.8 inch). BE type and PE type products: monochrome LED to display numbers and characters, total 22-character and 18 LED indicator lamps. PC type products: dot matrix LCD panel, in addition to display weight, unit price, amount and other information, can also display the name of commodity, traceability code and prompt message of operation. Multilateral Languages of commodity and prompt message can be displayed according to requirements.

1.3 Features description of keyboard and key



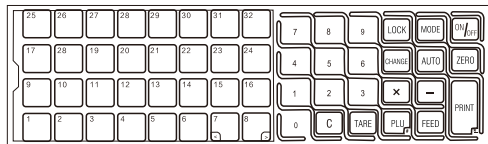



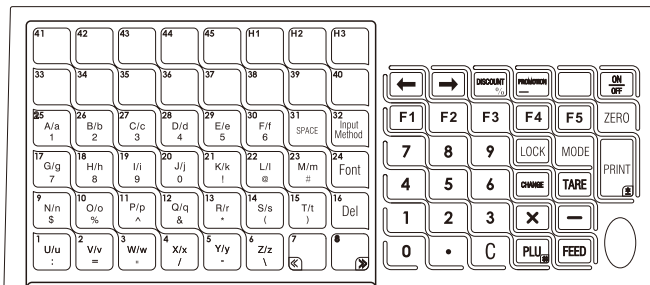



- B type















- P type



Instruction table of function of key

On/Off key	
	※Will display “On” or “Off ”
PLU shortcut Keys	
 ~ 	※Commodity shortcut key ; enter characters when editing a product name , where P32 can select input method and P24 can replace font size.
Number keys	
 ~ 	※Enter number
Tare key	
	※Set or clear tare
Clear key	
	※Abdicate or clear numbers
Rezero key	
	※Rezero weight to 0”
Mode key	
	※Working mode switch
Lock key	
	※Lock tare or unit price

✕” key	
	※For entering quantity in transaction mode; linefeed key when editing commodity and product name
“_” key	
	※Can cancel a transaction in the cumulative transaction.
Subtotal / change key	
	※Operation key of subtotal and change
Project Code key	
	※Call a product by a value key and this key in the transaction state. ; Is a save key in editing state.
Paper Load key	
	※Paper load key. Press this key to locate label after installation of printing paper; it is a exit key in editing state.
Print key	
	※Print key. It is confirmation or printing function key in transaction mode; it is operation confirmation key in editing mode.
Cumulative key	
 	※Cumulative action key to realize cumulative operation of five batches.
Page up key	
	※Page up in browse mode or network setup mode.

Page down key	
	※Page down in browse mode or network setup mode.
Discount key	
	※It is in percent discount key in transaction mode; it is delete function key in editing mode.
Allowance key	
	※Amount allowance operation key.
Browse key	
	※In network setting state, you can browse to search for a wireless WIFI SSID

II. Paper Load, Poling and Fixing of Display Module and Horizontal Adjustment

2.1 Paper loading

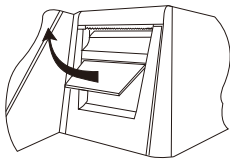

1. Lift to open the cover plate

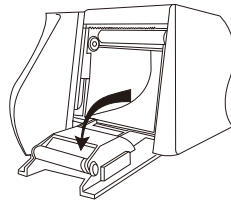

2. Open paper loading bin

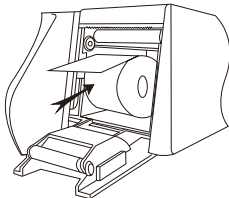

3. Place printing paper

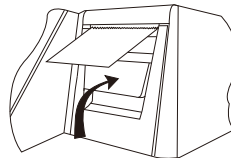

4. Close cover plate, paper loading complete.

2.2 Poling installation of display module

Step 1: Set the poling sleeve into the pole in the correct direction, connect well the connecting line of display module with connecting line of scale body, and use four round head screws to fix the display module of scale on the metal base of the weighing body;

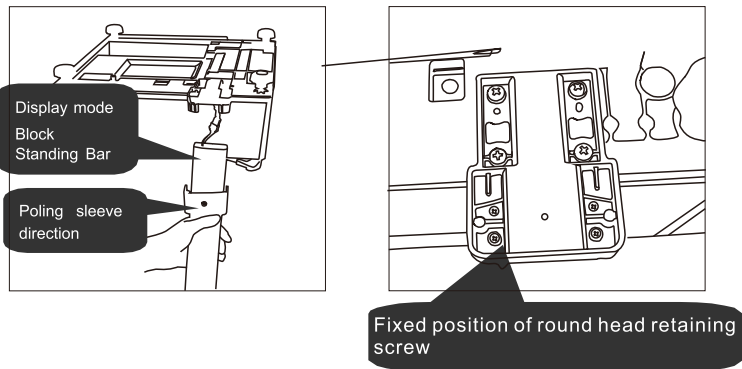

Step 2: Confirm the connection line is free of extrusion, fixing of poling is free of skew, and then use a countersunk head screw to fix poling sleeve.

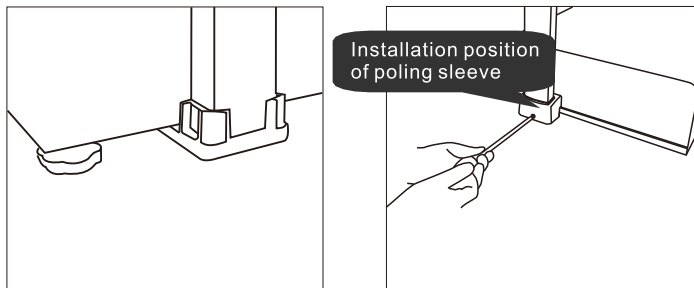

2.3 Horizontal adjustment

As shown in the figure, adjust the four feet under the base to adjust the horizontal bubble to the center of the circle area.

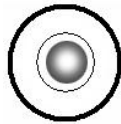
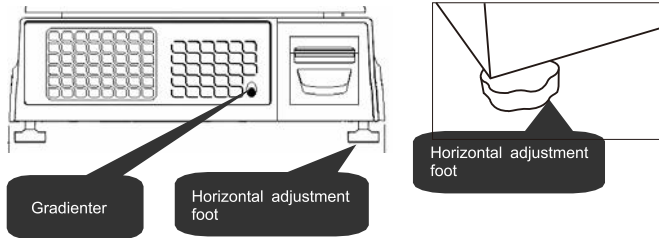

Correct operation: gradienter bubbles are in the center

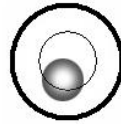

Incorrect operation: gradienter bubbles are not in the center

III. Basic Operation

3.1. Preparation before use

3.1.1 Four feet of the scale are reliably down to the ground; adjust four feet of scale to make the level of bead in the center.

3.1.2 Start up, scale self-test, complete display:

0.000

0.000

0.00

0.00

3.1.3 Properly install receipt paper and paper feeding is normal after press [FEED] key without an error.

The switch key is used to switch on or off the electronic scale, but It does not affect battery charge

3.2. Power on/power off/charge

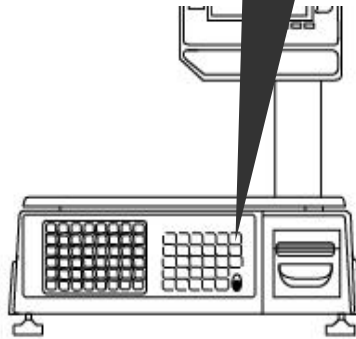

3.2.1 Position diagram of power switch of electronic scale

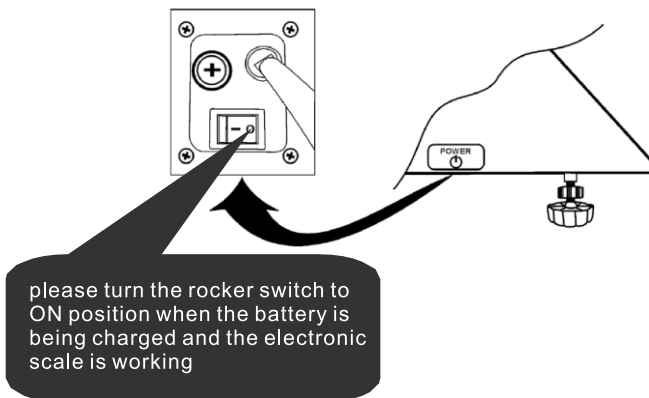

3.2.2 Power on

Plug the electronic scale into the electric supply 220V, and then switch the rocker switch below the electronic scale to ON position, the electronic scale is switched on and entered into standby interface of default system, the weight is shown as 0.

If use of electronic scales in the absence of mains supply, you can directly press [on/off] key on the keyboard panel and at this time the electronic scale is running in the battery-powered state.

3.2.3. Power off

If the electronic scale is needed to be off, user can press [on/off] key on the keyboard panel to power off the electronic scale. If the electronic scale is not used for a long time, please press [on/off] key on the keyboard panel to power off the electronic scale, and then switch the rocker switch on the bottom of scale to Off position.

3.2.4. Charge

Plug the electronic scale into the electric supply 220V, and then switch the rocker switch below the electronic scale to ON position, the battery is in charging state. Either On or Off of the On/Off key on the keyboard panel will not affect charging.

Note: Please check all accessories when unpacking and please contact us or the designated seller if there is any defect. Actual product configuration and display interface may be slightly different from the manual, subject to the actual product.

Customer service center

Tel: 021-59757333 Fax: 021-69758439

E-mail: Address: No. 788 Songxiu Road, Qingpu Industrial Area,
Qingpu District, Shanghai

Zip code:201700

IV. Setup of System Function (SPEC LIST) and Allocation of Function (FUNCTION KEY)

4.1 List of settings of user functions (SPEC 141)

No.	Content		Default Value	Range of Value	Remark
001	F1F2 default value of weighing commodity		21	0~99	
002	F1F2 default value of non-weighing commodity		24	0~99	
003	Weighting bar code format		0	0~23	
	0	2F5C5XS	1	1F6C5XS	
	2	2F10CS	3	2F5C5P5XS	
	4	2F5C5X5PS	5	1F6C5P5XS	
	6	1F6C5X5PS	7	2F4C6XS	
	8	1F4C7XS	9	1F5C6XS	
	10	2F4C5X6PS	11	2F4C6P5XS	
	12	1F5C5X6PS	13	1F5C6P5XS	
	14	None	15	UDF1	
	16	UDF2	17	UDF3	
	18	UDF4	19	UDF5	
	20	UDF6	21	2F4CXCD5XS	
	22	1F5CXCD5XS	23	2F5CXCD4XS	
	24	1F6CXCD4XS			
004	Non-weighting bar code format		0	0~23	
	0	2F5C5XS	1	2F5C5XS	
	2	2F10CS	3	2F10CS	
	4	2F5C5X5PS	5	2F5C5X5PS	
	6	1F6C5X5PS	7	1F6C5X5PS	
	8	1F4C7XS	9	1F4C7XS	
	10	2F4C5X6PS	11	2F4C5X6PS	
	12	1F5C5X6PS	13	1F5C5X6PS	
	14	None	15	None	
	16	UDF2	17	UDF2	
	18	UDF4	19	UDF4	
	20	UDF6	21	UDF6	
	22	1F5CXCD5XS	23	1F5CXCD5XS	
	24	1F6CXCD4XS		1F6CXCD4XS	

005	Weighting bar code type			2	0~2	
	0	Weight	1	Quantity		
	2	Amount				
006	Non-weighting bar code type			2	0~2	
	0	Weight	1	Quantity		
	2	Amount				
008	Uses bar code setting defined in SPEC			0	0~1	
	0	No	1	Yes		
010	Support card swiping start-up			0	0~1	
	0	No	1	Yes		
011	formatting length of OLUNO in Label Printing			6	1~6	
016	Default charge unit			0	0~7	
	0	Controlled by commodity	1	Yuan/Kg		
	2	Yuan/g	3	Yuan/10g		
	4	Yuan/100g	5	Yuan/500g		
	6	Yuan/t	7	Yuan/1b		
017	Default font of product name			0	0~8	
	0	Controlled by commodity	1	G0		
	2	G1	3	G2		
	4	G3	5	G4		
	6	G5	7	G6		
	8	G7				
018	Default font of ingredient			0	0~8	
	0	Controlled by commodity	1	G0		
	2	G1	3	G2		
	4	G3	5	G4		
	6	G5	7	G6		
	8	G7				

019	Default font of special information			0	0~8	
	0	Default font of special information	1	G0		
	2	G1	3	G2		
	4	G3	5	G4		
	6	G5	7	G6		
	8	G7				
024	Opening delay of cash box			0	0~9	
	0	With hardware control	1	40 milliseconds		
	2	80 milliseconds	3	120 milliseconds		
	4	160 milliseconds	5	200 milliseconds		
	6	240 milliseconds	7	280 milliseconds		
	8	320 milliseconds	9	360 milliseconds		
029	Settings of display brightness			2	0~4	
	0	Dark	1	Relatively dark		
	2	Normal	3	Relatively bright		
	4	Bright				
030	Display will be dark when system is idle for seconds			0	0~99999	
031	Display will be off when system is idle for seconds of			0	0~99999	
032	Printer will auto sleep when it is idle for seconds of			60	0~99999	
033	Automatic detection if printer is paper out			1	0~1	
	0	No	1	Yes	1	0~1
034	Cumulative processing mode of unlocked pRezero			0	0~1	
	0	Two kinds of tare cumulative	1	Prezero tare covers commodity tare		

035	barcode format for statistical label		0	0~25	
	0	Controlled by commodity attributes			
	1	2F5C5XS	2	1F6C5XS	
	3	2F10CS	4	2F5C5P5XS	
	5	2F5C5X5PS	6	1F6C5P5XS	
	7	1F6C5X5PS	8	2F4C6XS	
	9	1F4C7XS	10	1F5C6XS	
	11	2F4C5X6PS	12	2F4C6P5XS	
	13	1F5C5X6PS	14	1F5C6P5XS	
	15	None	16	UDF1	
	17	UDF2	18	UDF3	
	19	UDF4	20	UDF5	
	21	UDF6	22	2F4CXCD5XS	
	23	1F5CXCD5XS	24	2F5CXCD4XS	
	25	1F6CXCD4XS			

No.	Content		Default Value	Range of Value	Remark
040	Upper limit of discount amount		1.000	0~1.000	
041	Upper limit of discount rate		50	0~100	
042	Print the original price in receipt mode		1	0~1	
	0	No	1	Yes	
043	Allow product promotion function		1	0~1	
	0	No	1	Yes	
044	Allow allowance function		1	0~1	
	0	No	1	Yes	
045	Allow discount function		1	0~1	
	0	No	1	Yes	
046	Do not print when the label amount overflows		1	0~1	
	0	No	1	Yes	

047	Open cash box when printing label			0	0~1	
	0	No	1	Yes		
048	Default label format			0	1~32	
	0 is to select label format specified for commodity, 1 ~ 32 is to directly use appropriate label format.					
049	shop name of label printing			1	1~32	
050	Weight on label shifts			0	0~7	
	0	No shift	1	Right shift 1 character		
	2	Right shift 2 characters	3	Right shift 3 characters		
	4	Left shift 1 character	5	Left shift 2 characters		
	6	Left shift 3 characters	7	Left shift 4 characters		
051	Quantity on label shifts			0	0~7	
	0	No shift	1	Right shift 1 character		
	2	Right shift 2 characters	3	Right shift 3 characters		
	4	Left shift 1 character	5	Left shift 2 characters		
	6	Left shift 3 characters	7	Left shift 4 characters		
052	Amount on label shifts			0	0~7	
	0	No shift	1	Right shift 1 character		
	2	Right shift 2 characters	3	Right shift 3 characters		
	4	Left shift 1 character	5	Left shift 2 characters		
	6	Left shift 3 characters	7	Left shift 4 characters		
053	Detect exfoliated state of label in automatic mode			1	0~1	
	0	No	1	Yes		
054	Also save transactions in label mode			0	0~1	
	0	No	1	Yes		
056	Print task after communication is complete			0	0~1	
	0	No	1	Yes		

057	The maximum communication tasks executed simultaneously			1	1~5	
058	Allow automatic backup of primary database (reboot required)			1	0~1	
	0	No	1	Yes		
060	Allow no commodity to print			0	0~1	
	0	No	1	Yes		
061	Allow automatic conversion of weighing and non-weighing			0	0~1	
	0	No	1	Yes		
062	Allow modification of unit price			1	0~1	
	0	No	1	Yes		
066	Product shortcut one-key printing			0	0~1	
	0	No	1	Yes		
067	Display unit price when browsing commodity			0	0~1	
	0	No	1	Yes		
068	Allow to lock the last commodity			0	0~1	
	0	No	1	Yes		

No.	Content			Default Value	Range of Value	Remark
069	Total amount is not displayed without commodity			0	0~1	
	0	No	1	Yes		
070	Automatically exit when stored value card is failed			0	0~1	
	0	No	1	Yes		
071	Automatically acquire commodity (for label printing only)			0	0~1	
	0	No	1	Yes		
072	Print EAN bar code of commodity in receipt mode			0	0~1	
	0	No	1	Yes		
073	Enable function of number + shortcut key to call a product			0	0~1	
	0	No	1	Yes		

085	Enable function of number + shortcut key to call a product			0	0	
	0	Neusoft UnionPay (20150930)				
090	Product snapshot mode			0	0~2	
	0	NONE		1	After weight is stable	
	2	After camera key				
091	Automatic tag deletion after transaction data is collected over the network			1	0~1	
	0	No		1	Yes	
092	Automatically clear transaction data after printing statement			0	0~1	
	0	No		1	Yes	
120	Printing mode of traceability information content			0	0~1	
	0	None		1	Print as QR code	
121	Printing of origin			1	0~1	
	0	No		1	Yes	
122	Lazy loading network			0	0~1	
	0	No		1	Yes	
123	Lazy loading network time (1~60 minutes)			10	1~60	
124	Time interval of automatic re-connection with WIFI (0~ 60 minute)			1	0~60	
130	Allow [Subtotal] key to perform function of reading traceability code card			0	0~1	
	0	No		1	Yes	
131	Allow [print] key to perform function of wholesale and sales and ignoring information of card writing information			0	0~1	
	0	No		1	Yes	
132	Allow [F5] key to perform function of browsing			0	0~1	
	0	No		1	Yes	
133	Trace code is forced to create for retail transactions			0	0~1	
	0	No		1	Yes	

138	Printing format of trace code			0	0~4	
	0	No	1	Yes		
	0	Do not print	1	Print numbers		
	2	Print as 128 code	3	Print as QR code		
	4	Print as 128 code and QR code				
145	Use UCC-EAN128 code to print 18-bit bar code			0	0~1	
	0	No	1	Yes		
146	Mandatory adoption of Code128Auto to print bar code (for label format only)			0	0~1	
	0	No	1	Yes		
147	Mandatory adoption of GM to print RQ code (for label format only)			0	0~1	
	0	No	1	Yes		
149	Delete existing approach information before reading traceability code card (valid only the "Enable quota function" is No)			0	0~1	
	0	No	1	Yes		
150	Enable quota function			0	0~1	
	0	No	1	Yes		
159	Enable quota function for non-weighing commodities			0	0~1	
	0	No	1	Yes		
160	Enable traceability function			0	0~1	
	0	No	1	Yes		

No.	Content			Default Value	Range of Value	Remark
162	Weight reduction percentage of zero judgment in compulsory functions			100	0~100	
		100				
163	Compulsory function			0	0~4	
	0	No compulsory function	1	Compulsory record		
	2	Compulsory printing and compulsory record	3	Compulsory payment and compulsory record		
	4	Compulsory record but no printing				
164	Receipt ticket format			0	0~5	
	0	Default	1	SZSM		
	2	LC	3	ZKR		
	4	HRH	5	DRPF		
165	Length of traceability number			3	1~6	
166	Printing format of trace code			1	0~3	
	0	Do not print	1	Print numbers		
	2	Print as 128 code	3	Print as QR code		
167	Printing format of inspection and quarantine code			1	0~3	
	0	Do not print	1	Print numbers		
	2	Print as 128 code	3	Print as QR code		
168	Icon of receipt letterhead			0	1~16	
169	Icon of receipt end			0	1~16	
170	Copies of auto copy of receipt and label			0	0~100	
171	Traceability code reader driver			0	0~7	
	0	SQ-ZM703(CPU)	1	SQ-ZM701 (S50)		
	2	SQ-ZM703 (M1)	3	LC-ZM703 (CPU)		
	4	ZKR-ZM703 (S70)	5	BY-ZM703 (CPU)		
	6	DR-ZM703 (CPU)	7	SQ-ZMS50 (S50WH)		
172	Stored value card reader driver			0	0~1	
	0	MDS	1	Dalian ZWM		
173	Printing of ticket statistical bar code			0	0~2	
	0	NoPrint	1	TZ		
	2	HFWC				

174	Citizen card reader driver			0	0	
175	Automatic data upload mode(reboot is required)			0	0~13	
	0	None	1	Shangqing- Qingdao		
	2	Inspur - Jinan	3	Neusoft - Yan'an		
	4	Digital Balance	5	Shanghai - poultry		
	6	Lanzhou - wholesale	7	Lanzhou - retail		
	8	Lanzhou - exclusive	9	Lanzhou - agricultural trade		
	10	Neusoft - Shijiazhuang	11	Base package		
	12	CyberPower	13	Dalian Zhang Wanming		
176	bar code scanner port			0	0~1	
	0	None	1	COM1		
177	Auto accumulation after scanning			0	0~5	
	0	None	1	F1		
	2	F2	3	F3		
	4	F4	5	F5		
178	Full capacity calibrated measuring unit of weight			0	0~3	
	0	Kg	1	G		
	2	t	3	Lb		
179	Harge unit of unit price when no commodity is called.			0	0~6	
	0	Yuan/Kg	1	Yuan/g		
	2	Yuan/10g	3	Yuan/100g		
	4	Yuan/500g	5	Yuan/t		
	6	Yuan/1b				

No.	Content				Default Value	Range of Value	Remark
180	Charge unit and unit of weight of printing of commodity				0	0~1	
	0	No	1	Yes			
181	Interval of automatic data upload(reboot is required)				0	0~4	
	0	Timely	1	1 minute			
	2	10 minutes	3	30 minutes			
	4	60 minutes					
182	Packer card reader drive				0	0~1	
	0	ZXCM (CPU)	1				
190	Adoption of delayed writing technology to improve efficiency of file reception				0	0~1	
	0	No	1	Yes			
191	Number of cache of delayed writing(1 ~ 10)				3	1~10	
200	Can only enter from Z Mode SPEC141				0	0~1	
	0	No	1	Yes			
220	Calculation method of bar code parity bit				0	0~1	
	0	Positive verification	1	Conversion verification			
300	Clerk management mode				0	0~3	
	0	Prohibit	1	Ordinary enable			
	2	Auto lock after a short idle time	3	Re-login after a short idle time			
301	Time of clerk free with operation (second)				0	0~1	
	0		1				
425	Printing concentration				5	0~9	
	0	Light (1)	1	Light (2)			
	2	Light (3)	3	Light (4)			
	4	Light (5)	5	Medium			
	6	Dark (1)	7	Dark (2)			
	8	Dark (3)	9	Dark (4)			
430	Shared LED display port of IC card imprint machine				0	0~1	
	0	No	1	Yes			

450	Trace mode when compatible with 9B90			0	0~1	
	0	Exclusive mode	1	Share mode		
460	Enable video integration services (reboot required)			0	0~1	
	0	No	1	Yes		
470	Allow automatic synchronization of system clock(reboot required)			0	0~1	
	0	No	1	Yes		
480	Network communication speed			0	0~6	
	0	Slowest	1	Slow		
	2	Slightly slower	3	Normal		
	4	Slightly faster	5	Fast		
	6	Fastest				
489	Color theme(reboot required)			0	0~1	
	0	Pure black	1	Sapphire blue gradient		
490	Language			0	0~1	
	0	Simplified Chinese	1	English		
491	Recording live log (every 5 seconds)			0	0~1	
	0	No	1	Yes		
492	Electronic scale and printer type			0	0~2	
	0	Automatic check	1	Label scale (without printer)		
	2	Receipt scale (without printer)				
493	Allow operation log of recording system			1	0~1	
	0	No	1	Yes		
495	ARM9 supports for LCD display (reboot required)			0	0~1	
	0	No	1	Yes		
498	Display P mode			0	0~1	
	0	No	1	Yes		

No.	Content	Default Value	Range of Value	Remark
499	The maximum transaction amount saved	5000	1~10000	
	5000			

4.2. Operation of settings of user functions (SPEC 141)

Example of setting operation of SPEC-141

Description	Operate	Display			
		Tare	Weight	Unit Price	Amount
R light on (transaction mode)		0.000	0.000	0.00	0.00
1. Enter function operation mode					
Press and hold [ZERO] key with right hand					
Press [1], [4], [1] with left hand and release both hands	[ZERO] + [1] [4] [1]	R1 41	Sp001	21	21
write [R + 141] for the following					
2. Query downward in sequence and press [PRINT] key	[PRINT]	R1 41	Sp002	24	24
3. Skip query, for example, query SP060, press[6] [0] [X]	[6] [0] [X]	R1 41	Sp060	0	0
4. To modify SP060 content, replace 0 with 1, Press [1] and then press [PRINT] key	[1] [PRINT]	R1 41	Sp061	0	0
5. Query upward in sequence and press [-]	[-]	R1 41	Sp060	1	1
6. Save and exit, press [PLU] key	[PLU]	0.000	0.000	0.00	0.00

4.3 . List of distribution of function key (FUNCTION KEY LIST)

Function key Encoding value description

Function key Encoding value	Key function description	Function key Encoding value	Key function description	Function key Encoding value	Key function description	Function key Encoding value	Key function description
FC.002	Allowance	FC.080	Traceability code 5	FC.092	H4	FC.150	Traceability code reading card
FC.003	Discount	FC.081	Traceability code 6	FC.093	H5	FC.151	Read citizen card
FC.009	Prepack aging quantity	FC.082	Traceability code 7	FC.096	Power supply switch	FC.152	Open cash box

FC.071	Salesclerk 1	FC.083	Traceability code 8	FC.098	Modify price of commodity	FC.153	Shop name key
FC.072	Salesclerk 2	FC.084	F1	FC.100	Option of traceability code	FC.155	Modify total amount
FC.073	Salesclerk 3	FC.085	F2	FC.101	Browse	FC.156	Wholesale sales
FC.074	Salesclerk 4	FC.086	F3	FC.102	Page up	FC.158	Photograph
FC.075	Salesclerk 5	FC.087	F4	FC.103	Page down	FC.159	Log in/ Logout
FC.076	Traceability code 1	FC.088	F5	FC.104	Reprint	FC.160	Read Unionpay card
FC.077	Traceability code 2	FC.089	H1	FC.105	Cash	FC.161	Read packer card
FC.078	Traceability code 3	FC.090	H2	FC.106	Stored value card	FC.162	Subtotal statistica I label
FC.079	Traceability code 4	FC.091	H3	FC.107	Sales return	FC.163	Total amount statistica I label

4. 4. Operation of distribution of function key

Operation example of distribution of function key

	Description	Operation Sequence	Display			
			Tare	Weight	Unit Price	Amount
	Allocate a [Sales Return] key on shortcut key		0.000	0.000	0.00	0.00
1	Enter edit mode and press [MODE] key twice	[MODE] [MODE]	S1	EDIT		PLU
2	Press [1] [3] [X] keys and enter allocation mode of function key	[1] [3] [X]	S13		0	FUNCKEY
	Press [PRINT] key	[PRINT]	S13.0	FC.002	0	DISCANT
3	Press [PRINT] key or press [-] key, select to FC.107	[PRINT]... or [-]...	S13.35	FC.107	0	SALBACK
4	Allocate [Sales Return] key to [P41]key and press [P41]	[P41]	S13.36	FC.150	41	TRCCARD
5	Press [PLU] key and save allocation of [Sales Return] key (to [P41])	[PLU]	S13	EDIT		FUNCKEY
6	Press [FEED] key and back to weighing mode (R mode)	[FEED]	0.000	0.000	0.00	0.00

4.5 . Communication settings (settings for local area network and WIFI)

4.5.1. Item list of communication settings

Items of communication settings	Description	Display			
		Tare	Weight	Unit Price	Amount
1. No. of machine (No. of scale) H01		H01 H01.1	EDIT EDIT	SCALE 16	INDEX INDEX
2. Wired network card (ETH0)MAC address	MAC address segment 1 MAC address segment 2	H02 H02.1 H02.2	EDIT EDIT EDIT	EDH0 320	MAC MAC MAC
H02	MAC address segment 3	H02.3	EDIT	0	MAC
	MAC address segment 4	H02.4	EDIT	0	MAC
	MAC address segment 5	H02.5	EDIT	0	MAC
	MAC address segment 6	H02.6	EDIT	0	MAC
3. Wired network card (ETH0)IP address	IP address segment 1 IP address segment 2	H03 H03.1 H03.2	EDIT EDIT EDIT	EDH0 192 168	IP IP IP
H03	IP address segment 3	H03.3	EDIT	0	IP
	IP address segment 4	H04.4	EDIT	16	IP
4. Wired network card (ETH0)subnet mask H04	MASK segment 1 MASK segment 2	H04 H04.1 H04.2	EDIT EDIT EDIT	ETH0 255 255	MASK MASK MASK
	MASK segment 3	H04.3	EDIT	255	MASK
	MASK segment 4	H04.3	EDIT	255	MASK
5. Wired network card (ETH0)subnet mask H05	GATEWAY segment 1 GATEWAY segment 2	H05 H05.1 H05.2	EDIT EDIT EDIT	ETH0 192 168	GATEWAY GATEWAY GATEWAY
	GATEWAY segment 3	H05.3	EDIT	1	GATEWAY
	GATEWAY segment 4	H05.4	EDIT	1	GATEWAY
6. Wired network card (ETH0) DNS H06	DNS segment 1 DNS segment 2	H06 H06.1 H06.2	EDIT EDIT EDIT	ETH0 192 168	DNS DNS DNS
	DNS segment 3	H06.3	EDIT	1	DNS
	DNS segment 4	H06.4	EDIT	1	DNS
7. IP address of server that imitatively uploads data H07	IP address segment 1 IP address segment 2	H07 H07.1 H07.2	EDIT EDIT EDIT	UPLOAD 0 0	IP IP IP
	IP address segment 3	H07.3	EDIT	0	IP
	IP address segment 4	H07.3	EDIT	0	IP

8. Port number of server that imitatively uploads data H08		H08 H08.1	EDIT EDIT	UPLOAD 0	PORT PORT
9. IP address of server that imitatively downloads data	IP address segment 1	H09 H09.1	EDIT EDIT	DOWNLD 0	IP IP
H09	IP address segment 2	H09.2	EDIT	0	IP
	IP address segment 3	H09.3	EDIT	0	IP
	IP address segment 4	H09.4	EDIT	0	IP
10. Port number of server that imitatively downloads data H10		H10 H10.1	EDIT EDIT	DOWNLD 0	PORT PORT
11. IP address of WIFI network card		H11	EDIT	WIFI	IP
H011	IP address segment 1	H11.1	EDIT	192	IP
	IP address segment 2	H11.2	EDIT	168	IP
	IP address segment 3	H11.3	EDIT	1	IP
	IP address segment 4	H11.4	EDIT	16	IP
12. Subnet mask of WIFI network card		H12	EDIT	WIFI	MASK
H12	MASK segment 1	H12.1	EDIT	255	MASK
	MASK segment 2	H12.2	EDIT	255	MASK
	MASK segment 3	H12.3	EDIT	255	MASK
	MASK segment 4	H12.4	EDIT	0	MASK
13. Default gateway of WIFI network card	GATEWAY segment 1	H13 H13.1	EDIT EDIT	WIFI 192	GATEWAY GATEWAY
H13	GATEWAY segment 2	H13.2	EDIT	168	GATEWAY
	GATEWAY segment 3	H13.3	EDIT	0	GATEWAY
	GATEWAY segment 4	H13.4	EDIT	1	GATEWAY
14. IP address of WIFI network card		H14	EDIT	WIFI	DNS
H14	DNS segment 1	H14.1	EDIT	192	DNS
	DNS segment 2	H14.2	EDIT	168	DNS
	DNS segment 3	H14.3	EDIT	1	DNS
	DNS segment 4	H14.4	EDIT	1	DNS

15. SSID H15 of AP of WIFI	"SSID" input characters or press [] key and then press [X] key to look up AP SSID, lastly press [PRINT]key to confirm	H15 H15.1	EDIT	WIFI EDIT	NODE NODE
16. Login password of WIFI AP H16	Press [PRINT] key to confirm after entering PASSWORD characters	H16 H16.1	EDIT EDIT	WIFI	PASWORD PASWORD
17. AP authentication method of WIFI H17	"AUMODE", press [PRINT] key to confirm after entering authentication method and characters	H17 H17.1	EDIT EDIT	WIFI	AUMODE AUMODE
18. AP encryptionmethod of WIFI H18	"PRIVACY", press [PRINT] key to confirm after entering encryption method and characters.	H18 H18.1	EDIT EDIT	WIFI	PRIVACY PRIVACY
19. APkey index of WIFI H19 (when in WAB encryption mode)	"KEYINDX", press [PRINT] key to confirm after entering key index and characters	H19 H19.1	EDIT EDIT	WIFI 0	KEYINDX KEYINDX
20. Setting of number of stall H20	"ID" Press [PRINT] key to confirm after entering number of stall in and characters	H20 H20.1	EDIT EDIT	STALL	ID ID
21. Setting of number of stall	"NO", press [PRINT] key to confirm after entering number of stall and characters	H21 H21.1	EDIT EDIT	STALL	NO NO
22. Setting of filing number of operator H22	"BANO", press [PRINT] key to confirm after entering filing number of operator and characters.	H22 H22.1	EDIT EDIT	STALL	BANO BANO
23. ID number of operator H23	"IDNO", press [PRINT] key to confirm after entering ID number of operator and characters	H23 H23.1	EDIT EDIT	STALL	IDNO IDNO
24. Phone number of operator H24	"PHONE NO", press [PRINT] key to confirm after entering phone number of operator and characters.	H24 H24.1	EDIT EDIT	STALL	PHONE PHONE
25. Number of Market H25	"INDEX", press [PRINT] key to confirm after entering number of market and characters	H25 H25.1	EDIT EDIT	MARKET	INDEX INDEX

26. Name of market H26	"NAME", press [PRINT] key to confirm after entering name of market and characters	H26 H26.1	EDIT EDIT	MARKET	NAME NAME
27. Node number of market H27	"INDEX", press [PRINT] key to confirm after entering nod number of market and characters	H27 H27.1	EDIT EDIT	NODE	INDEX INDEX
28. Node number of market H28	"NAME", press [PRINT] key to confirm after entering node name of market and characters	H28 H28.1	EDIT EDIT	NODE	NAME NAME
29. Download IP address of upgrade patch from INTERNET H29	IP address segment 1 IP address segment 2 IP address segment 3 IP address segment 4	H29 H29.1 H29.2 H29.3 H29.4	EDIT EDIT EDIT EDIT EDIT	UPGRAD 140 207 0 74	IP IP IP IP IP
30. communication code (8 decimal numbers) H30 (Use user ID when using background system of bs framework of DB)	"CODE", press [PRINT] key to confirm after entering communication code and characters	H30 H30.1	EDIT EDIT	CC 0	CODE CODE
31. From USB disk initialization to import network setup parameters H31 (Directly import initialization network parameters from USB disk)	"FROMUSB", press [PRINT] key to confirm after entering 1,import initialization network parameters from USB disk	H31 H31.1 H31.1	EDIT EDIT EDIT	INIT 0 1	FROM USB FROM USB FROM USB
32. WEBSERVICE URL address H32	URL enter WEBSERVICE URL address, press [PRINT] key to confirm and save after entering characters,	H32 H32.1	EDIT EDIT	WEBSVC	URL URL

4.6. Operation instance of settings of wired network IP address:H03 (for example IP address is 192.168.0.16)

Description	Operation	Display			
		Tare	Weight	Unit Price	Amount
R light on (transaction mode)		0.000	0.000	0.00	0.00
1. Press and hold [ZERO] key with right hand and press [1 1 2] with left hand. Release both hands and enter settings for local area network and WIFI	[R] + [1], [1], [2]	H01	EDIT	SCALE	INEDX
2. Press [X] key twice, and enter setting of local area network IP address	[X], [X]	H03	EDIT	EDH0	IP
3. Press [PRINT] key and enter [192]	[PRINT], [1], [9], [2]	H03.1	EDIT	192	IP
4. Press [PRINT] key and enter [168]	[PRINT], [1], [6], [8]	H03.2	EDIT	168	IP
5. Press [PRINT] key and enter [0]	[PRINT], [0]	H03.3	EDIT	0	IP
6. Press [PRINT] key and enter [16]	[PRINT], [1], [6]	H03.4	EDIT	16	IP
7. Press [PRINT] key to confirm, setting of local area network subnet mask	[PRINT]	H04	EDIT	EDH1	IP
8. Press [PLU]key to save and exit.	[PLU]	0.000	0.000	0.00	0.00

4.7. Operation instance of settings of IP address and AP of wireless WIFI network card (H11)

(For example, IP address OF WIFI Network card of the scale is 192.168.1.25,SSID of AP is 123456 and password is 888888)

Description		Operation	Display			
			Tare	Weight	Unit Price	Amount
R light on (transaction mode)			0.000	0.000	0.00	0.00
1.	Press and hold [ZERO] key with right hand and press [112] with left hand release both hands and enter settings for local area network and WIFI settings	[R] + [1], [1], [2]	H01	EDIT	SCALE	INDEX
2.	Press [X] key 10 times , and enter setting of IP address of WIFI network card	[X], [X], [X], [X], [X] [X], [X], [X], [X], [X]	H11	EDIT	WIFI	IP
3.	Press [PRINT] key, enter [192]	[PRINT], [1], [9], [2]	H11.1	EDIT	192	IP
4.	Press [PRINT] key, enter [168]	[PRINT], [1], [6], [8]	H11.2	EDIT	168	IP
5.	Press [PRINT] key, enter [1]	[PRINT], [1]	H11.3	EDIT	1	IP
6.	Press [PRINT] key, enter [25]	[PRINT], [2], [5]	H11.4	EDIT	25	IP
7.	Press [PRINT] key to confirm, setting of local area network subnet	[PRINT]	H12	EDIT	WIFI	MASK
8.	Press [X] key 3 times and then press [PRINT] key once enter search input mode of WIFI Network card SSID.	[X], [X], [X], [PRINT]	H15 H15.1	EDIT EDIT		NODE NODE
9.	Press [] key to search and then press [X] key to search SSID of AP.	[] [X]	H112 H112	SELCT SELCT	WIFIAP WIFIAP	 123456
10.	Press [PRINT] key after search SSID of AP, Press [PRINT] key to confirm, and then press [PRINT] key once to enter for next step	[PRINT] [PRINT] [PRINT]	H15.1 H16 H16.1	EDIT EDIT EDIT	123456 WIFI	NODE PASWORD PASWORD
11.	Press number key [888888] and input AP password.	[8]. [8], [8], [8], [8], [8], [8]	H16.1	EDIT	888888	PASWORD

12.	Press [PRINT] key to confirm	[PRINT]	H17	EDIT	WIFI	AUMODE
13.	Press [PLU] key to save and exit.	[PLU]	0.000	0.000	0.00	0.00

V. System Calibration, Basic Parameter Settings and Operation Instance

5. 1. Weight calibration (this operation shall be done by personnel with professional qualification or professional maintenance personnel)

Firstly, turn on the calibration switch: Remove lead sealing on the bottom, unscrew the screw in the inner lead seal, insert the seal screw hole with a fine stick or toothpick, and push upwards the calibration switch. When "SPAN SW ON" is displayed, it states that calibration switch is on.

Description	Operation	Display			
		Tare	Weight	Unit Price	Amount
R light on (transaction mode)		0.000	0.000	0.00	0.00
1. Press and hold [ZERO] key with right hand and press [9] [8] [1] [1] with left hand and release both hands	[R]+[9], [8], [1], [1]	CALL	F.C.	15.000	
2. Enter weight used for calibration For example: 5.000Kg, enter [5] [0] [0] [0]	[5], [0], [0], [0]	CALL	F.C.	5.000	
3. Press [PRINT] key and prepare calibration of 0	[PRINT]		CAL 00		
4. Press [PRINT] key, in process of calibration of 0	[PRINT]			
5. Automatic display after calibration of 0			CAL SP	5.000	
6. Put 5.000Kg weight on the scale and press [PRINT] key after waiting for 10 seconds	[PRINT]			
7. Wait, wait for ten seconds		0.000	5.000	0.00	0.00
8. Calibration complete					

5.2. Edit of date and time

Description	Display				Remark
	Tare	Weight	Unit Price	Amount	
Press [MODE], [MODE]	S1	EDIT		PLU	
Press [1], [7], [X], [PRINT]	S17.0	ITEM	160311	DATE	
Press [2], [0], [1], [6], [0], [3][1][2]	S17.0	ITEM	160312	DATE	Enter 4 digits of year 2 digits for month and 2 digits for date
Press [PRINT]	S17.1	ITEM	123101	TIME	
Press [1], [6], [2], [3], [0], [0]	S17.1	ITEM	162300	TIME	Enter 2 digits of hour and two digits of minutes and 2 digits of second
Press [PRINT] and press [PLU] to save	S17	EDIT		SYSTEM	Press [PLU] to save
Press [FEED] to go back	0.000	0.000	0.00	0.00	Back weighing mode

5.3. Edit of visibility of commodity

Visibility of commodity when editing a product (item of visibility: number of item S0.0, product name S0.1 , retail unit Price S0.2 , non-weighing items S0.29)

	Operation	Display			
		Tare	Weight	Unit Price	Total Amount
		0.000	0.000	0.00	0.00
1. Enter editing mode (S1 commodity editing mode)	[MODE] [MODE]	S1	Edit		PLU
2. Enter editing of visibility of commodity	[0] [X]	S0	Edit	0	PLUSEL
3. Confirm Number of commodity is visible (1 is for visible item)	[PRINT] [1]	S0.0 S0.0	item item	1 1	PLUNO PLUNO

4. Confirm Name of commodity is visible (1 is for visible item)	[PRINT] [1]	S0.1 S0.1	item item	1 1	PLUNAME PLUNAME
5. Confirm Retail unit price is visible (1 is for visible item)	[PRINT] [1]	S0.2 S0.2	item item	1 1	SLPRC SLPRC
6. Confirm The highest price is invisible (0 is for invisible item)	[PRINT] [0]	S0.3 S0.3	item item	1 0	MAXPRC MAXPRC
7. Confirm The format of label is invisible (0 is for invisible item)	[PRINT] [0]	S0.4 S0.4	item item	1 0	LFMT LFMT
8. Confirm The format of bar code is invisible (0 is for invisible item)	[PRINT] [0]	S0.5 S0.5	item item	1 0	BCDFMT BCDFMT
9. Confirm F1F2 is invisible (0 is for invisible item)	[PRINT] [0]	S0.6 S0.6	item item	1 0	F1F2 F1F2
10. Confirm Item code is invisible (0 is for invisible item)	[PRINT] [0]	S0.7 S0.7	item item	1 0	ITCODE ITCODE
11. Confirm The type of bar code is invisible (0 is for invisible item)	[PRINT] [0]	S0.8 S0.8	item item	1 0	BCDTYP BCDTYP
12. Confirm Main group number is invisible (0 is for invisible item)	[PRINT] [0]	S0.9 S0.9	item item	0 0	GRPN O GRPN
13. Confirm Tax number is invisible (0 is for invisible item)	[PRINT] [0]	S0.10 S0.10	item item	0 0	TAXNO TAXNO
14. Confirm Reference code is invisible (0 is for invisible item)	[PRINT] [0]	S0.11 S0.11	item item	0 0	BLCNO BLCNO
15. Confirm Feature code is invisible (0 is for invisible item)	[PRINT] [0]	S0.12 S0.12	item item	0 0	TAGNO TAGNO

16. Confirm charge unit is invisible (0 is for invisible item)	[PRINT] [0]	S0.13 S0.13	item item	0 0	WTUNIT WTUNIT
17. Confirm Sales date is invisible (0 is for invisible item)	[PRINT] [0]	S0.14 S0.14	item item	0 0	SDAY SDAY
18. Confirm Sales time is invisible (0 is for invisible item)	[PRINT] [0]	S0.15 S0.15	item item	0 0	STIM STIM
19. Confirm Validity date is invisible (0 is for invisible item)	[PRINT] [0]	S0.16 S0.16	item item	0 0	VDAY VDAY
20. Confirm Packaging date is invisible (0 is for invisible item)	[PRINT] [0]	S0.17 S0.17	item item	0 0	PDAY PDAY
21. Confirm Packaging time is invisible (0 is for invisible item)	[PRINT] [0]	S0.18 S0.18	item item	0 0	PTIM PTIM
22. Confirm VIP selling price is invisible (0 is for invisible item)	[PRINT] [0]	S0.19 S0.19	item item	0 0	VIPPRC VIPPRC
23. Confirm Cost unit rice is invisible (0 is for invisible item)	[PRINT] [0]	S0.20 S0.20	item item	0 0	CSPRC CSPRC
24. ConfirmTare is invisible (0 is for invisible item)	[PRINT] [0]	S0.21 S0.21	item item	0 0	TARE TARE
25. Confirm Prepackaging quantity is invisible (0 is for invisible item)	[PRINT] [0]	S0.22 S0.22	item item	1 0	QTY QTY
26. Confirm Special information is invisible (0 is for invisible item)	[PRINT] [0]	S0.24 S0.24	item item	1 0	DSC DSC
27. Confirm Ingredient is invisible (0 is for invisible item)	[PRINT] [0]	S0.25 S0.25	item item	1 0	INGRE INGRE

28. Confirm Place of origin is invisible (0 is for invisible item)	[PRINT] [0]	S0.26 S0.26	item item	0 0	ADDR ADDR
29. Confirm Trace code source is invisible (0 is for invisible item)	[PRINT] [0]	S0.27 S0.27	item item	1 0	TRACSRC TRACSRC
30. Confirm Trace code group is invisible (0 is for invisible item)	[PRINT] [0]	S0.28 S0.28	item item	1 0	TRACGRP TRACGRP
31. Confirm Non-weighing commodity is visible (1 is for visible item)	[PRINT] [0]	S0.29 S0.29	item item	0 1	ISUNIT ISUNIT
32. Confirm Printing trace code is invisible (0 is for invisible item)	[PRINT] [0]	S0.30 S0.30	item item	1 0	PRTRAC PRTRAC
33. Confirm Printing of sales date is invisible (0 is for invisible item)	[PRINT] [0]	S0.31 S0.31	item item	0 0	PRTSDAT PRTSDAT
34. Confirm Printing of sales time is invisible (0 is for invisible item)	[PRINT] [0]	S0.32 S0.32	item item	0 0	PRTSTIM PRTSTIM
35. Confirm Printing of validity date is invisible (0 is for invisible item)	[PRINT] [0]	S0.33 S0.33	item item	0 0	PRTVDAT PRTVDAT
36. Confirm Printing of packaging date is invisible (0 is for invisible item)	[PRINT] [0]	S0.34 S0.34	item item	0 0	PRTPDAT PRTPDAT
37. Confirm Printing of packaging time is invisible (0 is for invisible item)	[PRINT] [0]	S0.35 S0.35	item item	0 0	PRTPTIM PRTPTIM
38. Confirm Open unit price is invisible (0 is for invisible item)	[PRINT] [0]	S0.36 S0.36	item item	0 0	OPENPRC OPENPRC
39. Confirm Discount and allowance permission is invisible (0 is for invisible item)	[PRINT] [0]	S0.37 S0.37	item item	0 0	ENABLED ENABLED

40. Confirm Control sales is invisible (0 is for invisible item)	[PRINT] [0]	S0.38 S0.38	item item	0 0	CNOTSAL CNOTSAL
41. Confirm Limit price permission is invisible (0 is for invisible item)	[PRINT] [0]	S0.39 S0.39	item item	0 0	LIMPRC LIMPRC
42. Save data	[PLU]	S0	Edit	0	PLUSEL
43. Back	[FEED]	0.000	0.000	0.00	0.00

5.4. Edit of commodity and distribution of shortcut key

5.4.1 Editing of weighing commodity (for example: to edit No.10 commodity, product name is "Pork 1", price per kilogram is "12.00", is a weighing item "0")

	Operation	Display			
		Tare	Weight	Unit Price	Total Amount
		0.000	0.000	0.00	0.00
1. Enter editing mode (S1 commodity editing mode)	[MODE] [MODE]	S1	Edit		PLU
2. Enter editing of S mode	[PRINT]	S1.0	ITEM	0	PLUNO
3. Enter number of commodity, such as No, 10 (note: the longest number of commodity is 6 digits) confirm	[10] [PRINT]	S1.0 S1.1	ITEM 1.01.G3	10	PLUNO PLUNAME
4. Enter product name	Pork 1				
	[P/p]"P" [O/o] [O/o]"o" [R/r] [R/r]"r" [K/k] [K/k]"k" [1] "1"	S1.1	1.06.G3		PLUNAME
Confirm	[PRINT]	S1.2	ITEM	0.00	SLPRC
5. Enter the price per kg of commodity, such as 12.00 Yuan/Kg	[1200]	S1.2	ITEM	12.00	SLPRC
Confirm	[PRINT]	S1.29	ITEM	0	ISUNIT

6. Weighing commodity is 0	[0]	S1.29	ITEM	0	ISUNIT
Confirm	[PRINT]	S1.0	ITEM		PLUNO
7. Save data	[PLU]	S1	Edit		PLU
8. Back	[FEED]	0.000	0.000	0.00	0.00

5.4.2 Editing of non-weighing commodity (for example: to edit No.14 commodity, product name is "Pork 2", price per kilogram is "16.00", is a non-weighing item "1")

	Operation	Display			
		Tare	Weight	Unit Price	Total Amount
		0.000	0.000	0.00	0.00
1. Enter editing mode (S1 commodity editing mode)	[MODE] [MODE]	S1	Edit		PLU
2. Enter editing of S mode	[PRINT]	S1.0	ITEM	0	PLUNO
3. Enter number of commodity, such as No, 14 (note: the longest number of commodity is 6 digits)	[1][4]	S1.0	ITEM	14	PLUNO
Confirm	[PRINT]	S1.1	1.01.G3		PLUNAME
4. Enter product name zone-location code	Pork 2				
	[P/p]"P" [O/o] [O/o]"o" [R/r] [R/r]"r" [K/k] [K/k]"k" [2]"2"	S1.1	1.06.G3		PLUNAME
Confirm	[PRINT]	S1.2	ITEM	0.00	SLPRC
5. Enter the price per bag of commodity, such as 16.00 Yuan/bag	[1][6][0][0]	S1.2	ITEM	16.00	SLPRC
Confirm	[PRINT]	S1.29	ITEM	0	ISUNIT
6. Non-weighing commodity is 1	[1]	S1.29	ITEM	1	ISUNIT
Confirm	[PRINT]	S1.0	ITEM		PLUNO
7. Save data	[PLU]	S1	Edit		PLU
8. Back	[FEED]	0.000	0.000	0.00	0.00

5.4.3 Allocate commodity (PLU) to shortcut key (for example: allocate No. 10 commodity to P2 shortcut key; allocate No. 14 commodity to P9 shortcut key)

	Operation	Display			
		Tare	Weight	Unit Price	Total Amount
		0.000	0.000	0.00	0.00
1. Enter editing mode (S1 commodity editing mode)	[MODE] [MODE]	S1	Edit		PLU
2. Select operation of allocation of commodity to shortcut key	[1] [2] [X]	S12	Edit	12	PLUKEY
3. Confirmation of PLU (commodity) allocation	[PRINT]	S12.0	Edit	0	1-01
4. Select shortcut, press continuously [PRINT] key 1-02: is P2 shortcut key for the first page (or press [P2] key)	[PRINT.....] or [P2]	S12.0	Edit	0	1-02
5. Enter commodity number No. 10	[10]	S12.0	Edit	10	1-02
Confirm	[PRINT]	S12.0	Edit	0	1-03
Repeat steps 4~5 and allocate multiple commodities					
4. Select shortcut, press continuously [PRINT] key 1-09: is P9 shortcut key for the first page (or press [P9] key)	[PRINT.....] or [P9]	S12.0	Edit	0	1-09
5. Enter commodity number No. 14	[1] [4]	S12.0	Edit	14	1-09
Confirm	[PRINT]	S12.0	Edit	0	1-10
6. Save	[PLU]	S12	Edit	9	PLUKEY
7. Back	[FEED]	0.000	0.000	0.00	0.00

5.5. Print transaction receipt

5.5.1 Printing of transaction voucher (use receipt paper)

Description	Display				Remark
	Tare	Weight	Unit Price	Amount	
					(Transaction voucher)
Method of printing transaction voucher for weighing commodities:					Number of stall: Number of machine: 16 Number of ticket : 00004
					2010.09.29 10:43:24 Salesclerk :00000
1. Place commodity	0.000	1.072	12.00	12.86	Weight/Quantity Unit Price: Yuan Amount: Yuan
Call for a weighing commodity					Product name: Pork 1
(Press [10 PLU] or [P2])					1.072
2. Press [PRINT] key, and print transaction voucher.					[Sales] Total 1 item Total amount: 12.86
					Charge:
					Cash: 12.86
Non-weighing commodity.					(Transaction voucher)
Method of printing transaction voucher for non-weighing commodities:					Number of stall: Number of machine: 16
1. Call for a non-weighing commodity.					2010.09.29 10:43:24 Salesclerk :00000
(Press [14 PLU] or [P9])	0.000	0.000	0.00	0.00	Weight/Quantity Unit Price: Yuan Amount: Yuan
2. If there are 3 pcs, then press [3] [X] key	PCS	1	16.00	16.00	Product name: Pork 2
4. Press [PRINT] key, and print transaction voucher.	PCS	3	16.00	48.00	3 x16.0048.00
	0.000	0.000	0.00	0.00	[Sales] Total 3 items

					Total amount: 48.00
					Charge:
					Cash: 48.00
Accumulation of weighing and non-weighing commodities					(Transaction voucher)
Method of printing transaction voucher for non-weighing commodities:	0.000	0.000	0.00	0.00	Number of stall: Number of machine: 16 Number of ticket : 00004
1. Place weighing products,	0.000	1.072	0.00	0.00	2010.09.29 10:43:24 Salesclerk :00000
Call for a weighing commodity	0.000	1.072	12.00	12.86	Weight/Quantity Unit Price: Yuan Amount: Yuan
Press [F1] key (accumulation key)	F1	total	1PCS	12.86	Product name: Pork 1
F1 light on, move away product					1.07212.0012.86
2. Call for a non-weighing commodity.	PCS	1	16.00	16.00	Product name: Pork 2
3. If there are 3 pcs, then press [3] [X]	PCS	3	16.00	48.00	3 x16.0048.00
Press [F1] key (accumulation key) 4. Press [PRINT] key, and print transaction voucher.	F1 0.000	total 0.000	4PCS 0.00	60.86 0.00	[Sales] Total 4 items Total amount: 60.86
					Charge:
					Cash: 60.86

5.5.2 Operating of cash payment and shortcuts allocation

5.5.2.1 [Cash] Allocation of shortcut keys

Description	Operation Sequence	Display			
		Tare	Weight	Unit Price	Total Amount
Allocate a [Cash] key on shortcut key		0.000	0.000	0.00	0.00
1. Press [MODE] key twice and enter edit mode	[MODE] [MODE]	S1	EDIT	0	PLU
2. Press[1] [3] [X] keys and enter function allocation	[1] [3] [X]	S13	EDIT	0	FUNCKEY
Press [PRINT] key and access to function key allocation mode	[PRINT]	S13.0	FC.002	0	DISCANT
3. Press [PRINT] key or press [-] key, select to FC.105	[PRINT] ... or[-]...	S13.33	FC.105		CASH
4. Allocate [Cash] key to [P41] shortcut, and press shortcut key [P41]	[P41]	S13.34	FC.106	0.00	PREPAID
5. Press [PLU] to save settings	[PLU]	S13	EDIT		FUNCKEY
6. Press [FEED] , go back	[FEED]	0.000	0.000	0.00	0.00

5.5.2.2 Cash Examples of payment operation

	Description	Operation Sequence	Display			
			Tare	Weight	Unit Price	Total Amount
			0.000	0.000	0.00	0.00
1.	When displaying transaction or accumulation, press [Change] key		PAY	SHULD	0.00	2.14
2.	Enter the amount of cash (equal to the amount payable, do not enter the amount of cash)		PAY	SHULD	5.00	2.14
3.	Press [Cash] key or press [PRINT] key, print ticket and display change		PAY	DONE	CHANGE	2.86
4.	Press [FEED] , go back		0.000	0.000	0.00	0.00

5.5.3 Operating of sales return and shortcuts allocation

5.5.3.1 [Sales Return] Allocation of shortcut keys

	Description	Operation Sequence	Display			
			Tare	Weight	Unit Price	Total Amount
	Allocate a [Sales Return] key on shortcut key		0.000	0.000	0.00	0.00
1.	Enter edit mode and press [MODE] key twice	[MODE] [MODE]	S1	EDIT		PLU
2.	Press [1] [3] [X] keys and enter function key allocation	[1] [3] [X]	S13	EDIT	0	FUNCKEY
		[PRINT]	S13.0	FC.002	0	DISCANT
3.	Press [PRINT] key or press [-] key, select to FC.107	[PRINT] ... or[-]...	S13.35	FC.107	0	SALBACK
7.	Allocate [Sales Return] key to [P41]key and press [P41] shortcut key	[P41]	S30.36	FC.150		TRCCARD

3	Press [PLU] to save	[PLU]	S13	EDIT	0.00	FUNCKEY
	Press [FEED] , go back	[FEED]	0.000	0.000		0.00

5.5.3.2 Example of sales return operation

	Description	Operation Sequence	Display			
			Tare	Weight	Unit Price	Total Amount
			0.000	0.000	0.00	0.00
1.	When displaying transaction or accumulation, press [Sales Return] key	[Sales Return]	PAY	SHULD	0.00	2.14
2.	Press [PRINT] key and print ticket	[PRINT]	PAY	DONE		
3.	Press [FEED] , go back	[FEED]	0.000	0.000	0.00	0.00

5.5. 4. Operation of discount, allowance and promotion

5.5.4.1 Example of discount operation

Description	Operation Sequence	Display			
		Tare	Weight	Unit Price	Total Amount
		0.000	0.000	0.00	0.00
1. Operation of discount of a single transaction					
(1) Discount operations of weighing commodity					
Place item and call for commodity, offer 10% discount(discount10%)		0.000	2.000	1.00	2.00
Enter [1] [0] [0] [0] (No decimal point) and press [Discount] key	[1][0][0][0][Discount]	0.000	2.000	0.90	1.80
Press [PRINT] key and print ticket	[PRINT]				
(2) Discount operations of non-weighing commodity					
Call for commodity		PCS	1	2.00	2.00
Enter quantity, if there are 3 pcs, then press [3] [X]	[3] [X]	PCS	3	2.00	6.00
Offer 10% discount, enter [1] [0] [0] [0] and press [Discount] key	[1][0][0][0][Discount]	PCS	3	1.80	5.40
Press [PRINT] key and print ticket	[PRINT]				
2. Accumulative discount operation					
When accumulation		F1	total	4PCS	8.00
offer 10% discount, enter [1] [0] [0] [0] and press [Discount] key	[1][0][0][0][Discount]	F1	total	4PCS	7.20
Press [PRINT] key and print ticket	[PRINT]				

5.5.4.2 Example of allowance operation

Description	Operation Sequence	Display			
		Tare	Weight	Unit Price	Total Amount
Allowance operation		0.000	0.000	0.00	0.00
1. Allowance operation for a single transaction					
1. Operation of allowance for weighing commodity, place item and call for commodity, offer 0.05Yuan discount.		0.000	2.150	1.00	2.15
Enter [5], press [PROMOTION] key and then press [PRINT] key to print ticket	[5][PROMOTION]	0.000	2.150	1.00	2.10
(2) Allowance operations of non-weighing		PCS	1	2.10	2.10
Enter quantity, if there are 3 pcs, then press [3] [X], offer 0.030Yuan discount.	[3] [X]	PCS	3	2.10	6.30
then enter [3][0] and press [PROMOTION] key	[3][0][PROMOTION]	PCS	3	2.10	6.00
Press [PRINT] key and print ticket	[PRINT]				
2. Allowance operation after accumulation		F1	total	2PCS	4.25
When accumulation, discount 0.05 Yuan, enter [5] and press [PROMOTION] key	[5][PROMOTION]	F1	total	2PCS	4.20
Press [PRINT] key and print ticket	[PRINT]				

Note: (1) When discount accumulation, discount for a single transaction shall not be allocated. When allowance is accumulated, it shall be allocated to a single transaction.

5.6. Operation of promotion

Setting data of regular or time-limited promotion shall be downloaded by background software(XDBManager), the specific operation can be referred to application manual of XDBManager .

Note:

Control/allow key of allowance function is the control/allow allowance which shall be set in user function, and set value of the project 044 is determined. May through SP141 function that correspond to Sp044; Control/allow discounts function key is control/allow discount function which is corresponding to SP045 function; Control/allow promotion function key is control/allow promotion function which is corresponding to SP043 function Deletion of commodity project key is to delete setting file of commodity promotion of the scale.

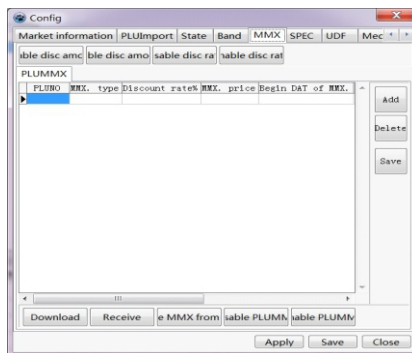

5.7. Cancellation operation of transaction

5.7.1 Cancellation operation of current transaction.

	Display				(Transaction voucher)
	Tare	Weight	Unit Price	Total Amount	Number of stall: Number of machine: 16 Number of ticket : 00004
	0.000	0.000	0.00	0.00	2010.09.29 10:43:24 Salesclerk :00000
1. (The first transaction) Place weighing product,	0.000	1.072	00.00	00.00	Weight/Quantity Unit Price: Yuan Amount: Yuan
Call for a weighing commodity	0.000	1.072	12.00	12.86	Product name: Pork 1
Press [F1] key (accumulation key)	F1	totAL	1PCS	12.86	1.07212.0012.86
F1 light on, move away product 2. (The second transaction) Call for a non-weighing commodity. 3. If there are 3 pcs, then press [3 X] Press [F1] key (accumulation key) 4. To cancel the current transaction, press [-] key	PCS F1	1 3 totAL	5.00 5.00 4PCS	5.00 15.00 27.86	[Sales] Total 1 item Total amount: 12.86 Charge: Cash: 12.86
5. Can proceed with operation	F1	totAL	1PCS	12.86	
6. Press [PRINT] key, and print transaction voucher.	0.000	0.000	0.00	0.00	

5.7.2 Cancellation operation of a certain transaction.

	Display				(Transaction voucher)
	Tare	Weight	Unit Price	Total Amount	Number of stall: Number of machine: 16 Number of ticket : 00004
1. (The first transaction) Place weighing product,	0.000	0.000	0.00	0.00	2010.09.29 10:43:24 Salesclerk :00000
Call for a weighing commodity	0.000	1.178	00.00	00.00	Weight/Quantity Unit Price: Yuan Amount: Yuan
Press [F1] key (accumulation key)	0.000	1.17	12.00	14.14	Product name: Pork 1
F1 light on, move away product	F1	totAL	1PCS	14.14	1.178 12.00 14.14
2. (The second transaction) Call for a non-weighing commodity.					Product name: Pork 3
3. If there are 3 pcs, then press [3] [X] key	PCS	1	16.00	16.00	0.396 5.00 1.98
Press [F1] key (accumulation key) 4. (The third transaction) Place weighing items and call for weighing commodity, enter unit price and then press [F1] key (cumulative key) intend to cancel the second transaction	PCS F1 0.000 F1	3 totAL 0.398 totAL	48.00 4PCS 5.00 5PCS	48.00 62.14 1.98 64.12	[Sales] Total 2 item Total amount: 16.12 Charge: Cash: 16.12
5. Press [2][-] key, the second transaction is canceled					
6. Press [PRINT] key, and print transaction voucher	F1	totAL	2PCS	16.12	
	0.000	0.000	0.00	0.00	

5.7.3 Cancellation operation of transaction slip.

Description	Display				
	Tare	Weight	Unit Price	Amount	
1. To cancel the current transaction slip					
When displaying accumulation	F1	totAL	5PCS	42.68	
press [X] key, operation of cancellation of transaction slip	0.000	0.000	0.00	0.00	

5.8. Printing of statement

Operation of statement printing mode(X mode)

Description	Operation	Display			
R light on (transaction mode)		0.000	0.000	0.00	0.00
1. To print "Sales Daily Statement":press[MODE] key	[MODE]	X0	EDIT		RPTDATE
Press [PRINT] key to confirm	[PRINT]	X0.0	ITEM	120928	DATE
Press [PLU] key and print "Sales Daily Statement" of 20120928.	[PLU]				
Enter 20120927 and print "Sales Daily Statement" of 20120927. subject to this, "Sales Daily Statement" of					
different date can be printed.					
2. To print "Sales of Salesclerk Daily Statement":press[MODE] key	[MODE]	X0	EDIT		RPTDATE
Press [1], [X] keys	[1], [X]	X1	EDIT		RPTCLK
Press [PRINT] key	[PRINT]	X1.0	ITEM	120928	DATE
[PLU] key, confirm	[PLU]				
Key, print "Sales of Salesclerk Daily Statement" of 20120928.					
Enter 20120927 and print "Sales of Salesclerk Daily Statement" of 20120927. subject to this, "Sales of					
Salesclerk Daily Statement" of different date can be printed.					
3. To print "Sales Daily Statement of Receiving Clerk":press[MODE] key	[MODE]	X0	EDIT		RPTDATE

Press [2], [X] keys	[2], [X]	X2	EDIT		RPTCLK
Press [PRINT] key	[PRINT]	X2.0	ITEM	120928	DATE
[PLU] key, confirm	[PLU]				
Key, print "Sales of Salesclerk Daily Statement" of 20120928.					
Enter 20120927 and print "Sales of Salesclerk Daily Statement" of 20120927. subject to this, "Sales of					
Salesclerk Daily Statement" of different date can be printed.					
4. To print "PLU Sales Daily Statement":press[MODE]	[MODE]	X0	EDIT		RPTDATE
Press [3], [X] keys	[3], [X]	X3	EDIT		RPTCLK
Press [PRINT] key	[PRINT]	X3.0	ITEM	120928	DATE
Press [PLU] key, print "PLU Sales Daily Statement" of 20120928.	[PLU]				
Enter 20120927 and print "Sales of Salesclerk Daily Statement" of 20120927.					
Subject to this, "PLU Sales Daily Statement" of different date can be printed.					
5. To print "Sales of Department Daily Statement":press[MODE] key	[MODE]	X0	EDIT		RPTDATE
Press [4], [X] keys	[4], [X]	X4	EDIT		RPTCLK
Press [PRINT] key, print "PLU Sales Daily Statement" of 20120928.	[PRINT]	X4.0	ITEM	120928	DATE
[PLU] key, confirm	[PLU]				

Enter 20120927 and print "Sales of Salesclerk Daily Statement" of 20120927.					
Subject to this, "Sales of Department Daily Statement" of different date can be printed.					
6. To print "Sales of Main Groups of Department Daily Statement":press[MODE] key	[MODE]	X0	EDIT		RPTDATE
Press [5], [X] keys	[5], [X]	X5	EDIT		RPT GRP
Press [PRINT] key to confirm	[PRINT]	X5.0	ITEM	120928	DATE
Press [PLU] key, print "PLU Sales Daily Statement" of 20120928.	[PLU]				
Enter 20120927 and print "Sales of Salesclerk Daily Statement" of 20120927.					
Subject to this, "Sales of Department Daily Statement" of different date can be printed.					
7. To print "Sales Monthly Statement":press[MODE] key	[MODE]	X0	EDIT		RPTDATE
Press [6], [X] keys	[6], [X]	X6	EDIT		RPTMON
Press [PRINT] key to confirm, and display begin date,	[PRINT]	X6.0	ITEM	130101	BDATE
Press [PRINT] key to confirm, and display end date,	[PRINT]	X6.1	ITEM	130130	EDATE
Press [PLU] key to print "Sales Monthly Statement".	[PLU]				

8. To print "PLU Sales Monthly Statement":press [MODE] key	[MODE]	X0	EDIT		RPTDATE
Press [7], [X] keys	[7], [X]	X7	EDIT		RPTMPLU
Press [PRINT] key to confirm, and display begin date,	[PRINT]	X7.0	ITEM	130101	BDATE
Press [PRINT] key to confirm, and display end date,	[PRINT]	X7.1	ITEM	130130	EDATE
Press [PLU] key to print "PLU Sales Monthly Statement".	[PLU]				
9. To print "Sales of Department Monthly Statement":press[MODE] key	[MODE]	X0	EDIT		RPTDATE
Press [8], [X] keys	[8], [X]	X8	EDIT		RPTMON
Press [PRINT] key to confirm and display begin date,	[PRINT]	X8.0	ITEM	130101	BDATE
Press [PRINT] key to confirm, and display end date,	[PRINT]	X8.1	ITEM	130130	EDATE
Press [PLU] key to print "Sales of Department Monthly Statement".	[PLU]				
10. To print "Sales of Main Groups Monthly Statement" :press[MODE] key	[MODE]	X0	EDIT		RPTDATE
Press [9], [X] keys	[9], [X]	X9	EDIT		RPTMON
Press [PRINT] key to confirm, and display begin date,	[PRINT]	X9.0	ITEM	130101	BDATE
Press [PRINT] key to confirm, and display end date	[PRINT]	X9.1	ITEM	130130	EDATE

Press [PLU] key to print "Sales of Main Groups Monthly Statement".	[PLU]				
11. "Export transaction flow data to USB disk": press [MODE] key	[MODE]	X0	EDIT		RPTDATE
Press [1], [0], [X] keys	[1], [0], [X]	X10	EDIT		EXPORT
Press [PRINT] key to confirm, and display begin date,	[PRINT]	X10.0	ITEM	130101	BDATE
Press [PRINT] key to confirm, and display end date,	[PRINT]	X10.1	ITEM	130130	EDATE
Press [PLU] key, export transaction flow to USB disk.	[PLU]				
12. "Printing of all commodity items": press [MODE] key	[MODE]	X0	EDIT		RPTDATE
Press [1], [1], [X] keys	[1], [1], [X]	X11	EDIT		PLUINFO
Press [PRINT] key to confirm, and display begin PLUNO, and enter beginning PLUNO	[PRINT]	X11.0	ITEM	0	BPLUNO
Press [PRINT] key to confirm, and display end PLUNO, and enter ending PLUNO	[PRINT]	X11.1	EDIT	0	EPLUNO
Press [PLU] key and print all commodity items.	[PLU]				
13. Press [FEED] key to go back	[FEED]	0.000	0.000	0.00	0.00

VI. Data Clear and Data Maintenance Mode (Z mode)

6.1. Operation instance and instruction of data clear (Z mode)

Description	Operation	Display			
		Tare	Weight	Unit Price	Total Amount
R light on (transaction mode)		0.000	0.000	0.00	0.00
1. To clear "SPEC File": press [MODE] key 3 times and enter clear mode (Z)	[MODE] [MODE] [MODE]	Z0	EDIT		CLRSPEC
Press [PRINT] key, (select input, 0: do not clear, or: 1: clear)	[PRINT]	Z0.0	ITEM	0	CLEAR
Enter [1], press [PLU] key to clear "SPEC file"	[1], [PLU]	Z0	EDIT		CLRSPEC
Press [FEED] key to go back.	[FEED]	0.000	0.000	0.00	0.00
2. To clear "Name of store, text, label format and other files": press [MODE] key 3 times	[MODE] [MODE] [MODE]	Z0	EDIT		CLRSPEC
Press [1], [X] key to clear its name of store, text, label format and other files.,	[1], [X]	Z1	EDIT	1	CLRTXT
Press [PRINT] key, (select input, 0: do not clear, or: 1: clear)	[PRINT]	Z1.0	ITEM	0	CLEAR
Enter [1], press [PLU] key to clear "Name of store, text, label format and other files"	[1], [PLU]	Z1	EDIT		CLRTXT
Press [FEED] key to go back	[FEED]	0.000	0.000	0.00	0.00

3. Clear "Commodity and Dedicated Trace File": press [MODE] key 3 times	[MODE] [MODE] [MODE]	Z0	EDIT		CLRSPEC
Press [2], [X] key to clear commodity and dedicated trace file.	[2], [X]	Z2	EDIT	2	CLRPLU
Press [PRINT] key, (select input, 0: do not clear, or: 1: clear)	[PRINT]	Z2.0	ITEM	0	CLEAR
Enter [1] and press [PLU] key to clear "Commodity and dedicated trace file".	[1], [PLU]	Z2	EDIT		CLRPLU
Press [FEED] key to go back.	[FEED]	0.000	0.000	0.00	0.00
4. Clear "Sales File":press [MODE] key 3 times	[MODE] [MODE] [MODE]	Z0	EDIT		CLRSPEC
Press [3], [X] key to clear sales file.	[3], [X]	Z3	EDIT	3	CLRSALE
Press [PRINT] key, (select input, 0: do not clear, or: 1: clear)	[PRINT]	Z3.0	ITEM	0	CLEAR
Enter [1], press [PLU] key to clear "Sales File"	[1], [PLU]	Z3	EDIT		CLRSALE
Press [FEED] key to go back.	[FEED]	0.000	0.000	0.00	0.00
5. Clear "Department, Main Group, Tax Rate File":press [MODE] key 3 times	[MODE] [MODE] [MODE]	Z0	EDIT		CLRSPEC
Press [4], [X] key to clear the department, main group and tax rate files.	[4], [X]	Z4	EDIT	4	CLROTHR
Press [PRINT] key, (select input, 0: do not clear, or: 1: clear)	[PRINT]	Z4.0	ITEM	0	CLEAR
Enter [1] and press [PLU] key to clear "Department, Main Group, Tax Rate File"	[1], [PLU]	Z4	EDIT		CLROTHR
Press [FEED] key to go back.	[FEED]	0.000	0.000	0.00	0.00

6. Clear "Redundant Data": Press [MODE] key 3 times	[MODE] [MODE] [MODE]	Z0	EDIT		CLRSPEC
Press [5] , [X] key, redundant data clearance	[5], [X]	Z5	EDIT	5	ZIPDB
Press [PRINT] key, (select input, 0: do not clear, or: 1: clear)	[PRINT]	Z5.0	ITEM	0	CLEAR
Enter [1] and press [PLU] to clear "Redundant Data".	[1], [PLU]	Z5	EDIT		ZIPDB
Press [FEED] key to go back.	[FEED]	0.000	0.000	0.00	0.00

6.2. Operation instance and instruction of data maintenance (Z mode)

Description	Operation	Display			
		Tare	Weight	Unit Price	Total Amount
R light on (transaction mode)		0.000	0.000	0.00	0.00
10. Rezero "System Database": Press [MODE] key 3 times	[MODE] [MODE] [MODE]	Z0	EDIT		CLRSPEC
Press [6] , [X] key, redundant data clearance	[6], [X]	Z6	EDIT	6	INITDB
Press [PRINT] key, (select input, 0: do not clear, or: 1: clear)	[PRINT]	Z6.0	ITEM	0	CLEAR
Enter [1] and press [PLU] to complete system database Rezero.	[1], [PLU]	Z6	EDIT		INITDB
Press [FEED] key to go back.	[FEED]	0.000	0.000	0.00	0.00
11. Restore "Factory Setting": Press [MODE] key 3 times	[MODE] [MODE] [MODE]	Z0	EDIT		CLRSPEC
Press [7], [X] key to restore factory setting,	[7], [X]	Z7	EDIT	7	RESTSYS
Press [PRINT] key, (select input, 0: do not restore, or: 1: restore)	[PRINT]	Z7.0	ITEM	0	CLEAR

Enter [1], press [PLU] key to complete restore of "Factory Setting"	[1], [PLU]	Z7	EDIT	0	RESTSYS
Press [FEED] key to go back.	[FEED]	0.000	0.000	0.00	0.00
12. Rapid initialization of "Product Information": Press [MODE] key 3 times	[MODE] [MODE] [MODE]	Z0	EDIT		CLRSPEC
Press [8], [X] key for rapid initialization of product information	[8], [X]	Z8	EDIT	8	INITPLU
Press [PRINT] key, commodity initialization mode, select product type:	[PRINT]	Z8.0	ITEM	0	MODE
(0: None; 1:Vegetables; 2:Fruit; 3:Cooked food; 4: Leisure food;					
5: Meat; 6:Dried Foods; 10: Aquatic product; 8:Breads;					
9:Grains; 10:Pickles; 11:Pastries)					
Enter initialization type of product to be used, such as enter 1 for "Vegetable",					
Enter [1] and press [PRINT] key and select "Vegetable"	[1], [PRINT]	Z8.1	ITEM	0	CLEAR
If clear all items, (select input, 0: Do not clear, or; 1: clear),					
"Clear all items",	[1]	Z8.1	ITEM	0	CLEAR
Enter [1] and press [PLU] to complete initialization of "Commodity Information".	[PLU]	Z6	EDIT		INITDB
Press [FEED] key to go back.	[FEED]	0.000	0.000	0.00	0.00
13. "Extract "System Operation Log": press [MODE] key 3 times	[MODE] [MODE] [MODE]	Z0	EDIT		CLRSPEC

Press [9], [X] to extract the system operation log.	[9], [X]	Z9	EDIT	9	RPTLOG
Press [PRINT] key and wait for input of extraction mode option	[PRINT]	Z9.0	ITEM	0	MODE
[PRINT]Z8.0ITEMMODE0	[1], [PLU]				
For example: Use USB interface to extract (export), please insert USB disk to USB interface		Z9	ITEM	1	MODE
Enter [1] and press [PLU] key to complete extraction of "System Operation Log".		Z9	EDIT		PRTLOG
Press [FEED] key to go back.	[FEED]	0.000	0.000	0.00	0.00
14. Extract "System Firmware Update Record": press [MODE] key 3 times	[MODE] [MODE] [MODE]	Z0	EDIT		CLRSPEC
Press [1] ,[0], [X] key to extract the system firmware upgrade record,	[1], [0], [X]	Z10	EDIT	10	RPTUPG
Press [PRINT] key and wait for input of extraction mode option	[PRINT]	Z10	ITEM	0	MODE
(Extraction mode, 0 : Nothing; 1:USB; 2: Internet)					
For example: Use USB interface to extract (export), please insert USB disk to USB interface	[1], [PLU]	Z10.0	ITEM	1	MODE
Enter [1] and press [PLU] key to complete extraction of "System Firmware Update Record".		Z10	EDIT		RPTUPG
Press [FEED] key to go back.	[FEED]	0.000	0.000	0.00	0.00
15. Backup "System Database":Press [MODE] key 3 times	[MODE] [MODE] [MODE]	Z0	EDIT		CLRSPEC
Press [1], [1], [X] key, system database backup	[1], [1], [X]	Z11	EDIT	11	BACKDB

Press [PRINT] key and wait for input of extraction mode option	[PRINT]	Z11.0	ITEM	0	MODE
(Extraction mode, 0 : Nothing; 1:USB; 2: Internet)	[1], [PLU]				
For example: Use USB interface to extract (export), please insert USB disk to USB interface		Z11.0	ITEM	1	MODE
Enter [1] and press [PLU] to complete backup of "System Database"		Z11	EDIT		BACKDB
Press [FEED] key to go back.	[FEED]	0.000	0.000	0.00	0.00
16. Extract "Date of Time Record for Weight Calibration": Press [MODE] key 3 times	[MODE] [MODE] [MODE]	Z0	EDIT		CLRSPEC
Press [1] , [2], [X] key to extract the date and time record for weight calibration	[1], [2], [X]	Z12	EDIT	12	BAKMARK
Press [PRINT] key, (extraction mode, 0: Nothing 1:USB; 2: Internet)	[PRINT]	Z12.0	ITEM	0	MODE
For example: Use USB interface to extract (export), please insert USB disk to USB interface	[1], [PLU]	Z12.0	ITEM		MODE
Enter [1] and press [PLU] key to complete "Date of Time Record for Weight Calibration".		Z12	EDIT	1	BAKMARK
Press [FEED] key to go back.	[FEED]	0.000	0.000	0.00	0.00
17. Backup of "User Data": press [MODE] key 3 times	[MODE] [MODE] [MODE]	Z0	EDIT		CLRSPEC
Press [1], [3], [X] key , backup of data	[1], [3], [X]	Z13	EDIT	13	BACKDB
Press [PRINT] key, backup of SPEC value, (0: None; 1: backup to USB disk)	[PRINT]	Z13.0	ITEM	0	SPEC

For example: Use USB interface to extract (export), please insert USB disk to USB interface	[1]	Z13.0	ITEM	1	SPEC
Enter [1] and press [PRINT] key, backup of network parameters	[PRINT]	Z13.1	ITEM	0	H112
Enter [1] and press [PRINT] key, backup of label format	[1], [PRINT]	Z13.2	ITEM	0	PLABEL
Enter [1] and press [PRINT] key, backup of customized label format	[1], [PRINT]	Z13.3	ITEM	0	UDF
Enter [1] and press [PRINT] key, main database	[1], [PRINT]	Z13.4	ITEM	0	MAINDB
For example enter [1],	[1]	Z13.4	ITEM	1	MAINDB
Press [PLU] key, to complete backup of "User Data".	[PLU]	Z13	EDIT		BACKUP
Press [FEED] key to go back.	[FEED]	0.000	0.000	0.00	0.00
18. Restore "User Data": press [MODE] key 3 times	[MODE] [MODE] [MODE]	Z0	EDIT		CLRSPEC
Press [1], [4], [X] key, data restore.	[1], [4], [X]	Z14	EDIT	14	RESTORE
Press [PRINT] key, restore SPEC value, (0: None; 1: restore from USB disk)	[PRINT]	Z14.0	ITEM	0	SPEC
For example: Use USB interface to extract (export), please insert USB disk to USB interface					
Enter [1] and press [PRINT] key, restore from network parameters	[1], [PRINT]	Z14.1	ITEM	0	H112
Enter [1] and press [PRINT] key, restore label format from USB disk	[1], [PRINT]	Z14.2	ITEM	0	PLABEL
Enter [1] and press [PRINT] key, restore customized label format from USB disk	[1], [PRINT]	Z14.3	ITEM	0	UDF

Enter [1] and press [PRINT] key, restore main database from USB disk	[1], [PRINT]	Z14.4	ITEM	0	MAINDB
Enter [1] and press [PLU] key to complete "Restore of Data"	[1], [PLU]	Z14	EDIT	9	RESTORE
Press [FEED] key to go back.	[FEED]	0.000	0.000	0.00	0.00
19. Auto backup and restore "Main Database": press [MODE] key 3 times	[MODE] [MODE] [MODE]	Z0	EDIT		CLRSPEC
Press [1],[5],[X] key, auto backup and restore main database	[1], [5], [X]	Z15	EDIT	15	RSD
Press [PRINT] key, store main database from system backup,	[PRINT]	Z15.0	ITEM	0	MODE
Enter [1] and press [PRINT] key, cover system back with main database	[1], [PRINT]	Z15.1	ITEM	0	MODE.1
(0:No, 1: Yes)					
Enter [1] and press [PLU] to complete backup of "Auto Backup and Restore of Main Database"	[1], [PLU]	Z15	EDIT		RSD
Press [FEED] key to go back.	[FEED]	0.000	0.000	0.00	0.00

VII. Operation Instances

7.1. Operation instances of user function settings(SPEC-141)

	Description	Operation	Display			
	R light on (transaction mode)		0.000	0.000	0.00	0.00
1.	Enter function operation mode					
	Press and hold [ZERO] key with right hand Press [1], [4], [1] with left hand and release both hands	[ZERO] + [1], [4], [1]		Sp001	21	21
	Write [R + 141] for the following					
2.	Query downward in sequence and press [PRINT] key	[PRINT]		Sp002	24	24
3.	Skip query, for example, query SP021, press[2][1][X]	[2][1][X]		Sp021	0	0
4.	To modify SP021 content, replace 0 with 1, Press [1], [PRINT]	[1], [PRINT]		Sp022	0	0
5.	Query upward in sequence and press [-]	[-]		Sp021	1	1
6.	Save and exit, press [PLU] key	[PLU]	0.000	0.000	0.00	0.00

7.2. When there is no product information (no PLU), how to realize that input unit price only to print receipt (Replace SP060=0 with SP060=1(refer to following operation)

	Description	Operation	Display			
	R light on (transaction mode)		0.000	0.000	0.00	0.00
1.	Enter function operation mode					
	Press and hold [ZERO] key with right hand Press [1], [4], [1] with left hand and release both hands	[ZERO] + [1], [4], [1]		Sp001	21	21
	Write [R + 141] for the following					
2.	Skip query, for example, query SP060, press[6][0][X]	[6][0][X]		Sp060	0	0

3.	To modify SP060 content, replace 0 with 1, Press [1], [PRINT] key	[1], [PRINT]		Sp061	0	0
4.	Save and exit,press [PLU] key	[PLU]	0.000	0.000	0.00	0.00

(The following operation is valid when SP060=1;
following operation is invalid when SP60=0.)

	Display				(Transaction voucher)
Method of printing transaction voucher for weighing commodities:	Tare	Weight	Unit Price	Total Amount	Shanghai DB Scale Co., LTD.
					Number of machine:#000000 Number of ticket: #0001
1. Place product (1.072kg), enter unit price	0.000	1.072	12.00	12.86	09-10-29 10:43 Salesclerk: #0099
(12:00 Yuan)					Kg Yuan/Kg Yuan
2. Press [PRINT] key, and print					1.072 12.00 12.86
transaction voucher.					Total amount 12.86
Non-weighing products,					(Transaction voucher)
Method of printing transaction voucher for non-weighing commodities:					Shanghai DB Scale Co., LTD.
	0.000	0.000	0.00	0.00	Number of machine:#000000 Number of ticket: #0002
1. Enter 3 pcs, press [3] [X]	PCS	3	0.00	0.00	09-10-29 10:44 AM Salesclerk: #0099
2. Enter unit price 5.00Yuan/pc press [5][0][0]	PCS	3	5.00	15.00	Kg Yuan/Kg Yuan
4. Press [PRINT] key, and print	0.000	0.000	0.00	0.00	3 X5.0015.00
transaction voucher.					Total amount15.00

7.3 When there is product information, how to realize that input unit price only to print receipt

(Replace SP062=0 with SP062=1(refer to following operation).

	Description	Operation	Display			
	R light on (transaction mode)		0.000	0.000	0.00	0.00
1.	Enter function operation mode					
	Press and hold [ZERO] key with right hand Press [1], [4], [1] with left hand and release both hands	[ZERO] + [1], [4], [1]		Sp001	21	21
2.	Skip query, for example, query SP062, press[6] [2] [X]	[6] [2] [X]		Sp062	0	0
3.	To modify SP062 content, replace 0 with 1, Press [1], [PRINT]	[1], [PRINT]		Sp063	0	0
4.	Save and exit, press [PLU] key	[PLU]	0.000	0.000	0.00	0.00

(The following operation is valid when SP62=1; following operation is invalid when SP62=0.)

	Display				(Transaction voucher)
	Tare	Weight	Unit Price	Total Amount	
					Shanghai DB Scale Co., LTD.
Method of printing transaction voucher for weighing commodities: 1. Place product, call for a weighing commodity and enter unit price	0.000	1.072	12.00	12.86	Number of machine:#000000 Number of ticket: #0001 09-10-29 10:43 Salesclerk: #0099 KgYuan/KgYuan
2. Press [PRINT] key, and print transaction voucher.					Pork 1 1.072 12.00 12.86
					Total amount 12.86
Method of printing transaction voucher for weighing commodities:					(Transaction voucher)
		1	5.00	5.00	Shanghai DB Scale Co., LTD
1. Call for a non-weighing commodity.	PCS	3	5.00	5.00	Number of machine:#000000 Number of ticket: #0002

2. If there are 3 pcs, then press [3] [X] key	PCS	3	5.00	15.00	09-10-29 10:44 AM Salesclerk: #0099
3. Enter unit price	PCS	3	6.00	18.00	Kg Yuan/Kg Yuan
4. Press [PRINT] key, and print transaction voucher.	0.000	0.000	0.00	0.00	Pork 2
					3 X 6.00 18.00
					Total amount18.00
Method of printing transaction voucher					(Transaction voucher)
weighing and non-weighing commodities:	0.000	0.000	0.00	0.00	Shanghai DB Scale Co., LTD.
1. Place product, call for a weighing commodity and enter unit price	0.000	1.072	12.00	12.86	Number of machine:#000000 Number of ticket: #0003
Press [F1] key (accumulation key) F1 light on,	F1	totAL	1PCS	12.86	09-10-29 10:43 Salesclerk: #0001
Move away product					Kg Yuan/Kg Yuan
2. Call for a non-weighing commodity.	PCS	1	5.00	5.00	Pork 1
3. If there are 3 pcs, then press [3] [X] key	PCS	3	5.00	15.00	1.072 12.00 12.86
4. Enter unit price 6.00Yuan/pc, press [6][0][0]	PCS	3	6.00	18.00	Pork 2
Press [F1] key (accumulation key)	F1	totAL	4PCS	30.86	3 X 6.00 18.00
5. Press [PRINT] key, and print transaction voucher.	0.000	0.000	0.00	0.00	Total amount 30.86

7.4 How to realize printing of information at letterhead of receipt paper (maximum 5 lines)

Note: Maximum five lines of information can be printed on the letterhead of receipt paper, which are No. 1, No. 23, No. 24, No. 25 and No.26 name of store, of which No.1 name of store placed in the middle, No. 23, 24, 25 and 26 name store is of left alignment. It occupies one line when there is content in the shop name and it does not occupy a line when there is no content. The font and size are determined by font and size of the shop name.

7.4.1. Editing of shop name

Description		Operation	Display			
R light on (transaction mode)			0.000	0.000	0.00	0.00
1.	Enter editing mode (S1 commodity editing mode)	[MODE] [MODE]	S1	Edit		PLU
2.	Enter editing of shop name, and press [2][X]	[2X]	S2	Edit		SHPNAME
	Press [PRINT] key	[PRINT]	S2.0	ITEM	0	TEXTNO
3.	Enter shop name, such as No. 1	[1]	S2.0	ITEM	1	TEXTNO
	Press [PRINT] key	[PRINT]	S2.1	1.01.G3		CONTEXT
4.	Enter location code of shop name	DB	S2.1	1.03.G3		CONTEXT
		[D/d] "D" [B/b] "B"				
	Select font, press [Font]key	[Font]	S2.1	1.03.G4		CONTEXT
5.	Save, press [PLU] key	[PLU]	S2	Edit		SHPNAME
6.	Exit, press [FEED]	[FEED]	0.000	0.000	0.00	0.00

7.5 How to realize printing of information at paper footing of receipt paper (maximum 6 lines)

Description: Maximum six lines of information can be printed on the paper footing of receipt, which are No.27, No.28, No.29, No.30, No.31 and No.32 shop name, shop name is of left alignment. It occupies one line when there is content in the shop name and it does not occupy a line when there is no content. The font and size are determined by font and size of the shop name.

7.6. How to realize that round up subtotal price on transaction receipt to ten-cent

(Replace SP506=0 with SP0506=1(refer to following operation).

Description	Operation	Display			
R light on (transaction mode)		0.000	0.000	0.00	0.00
1. Enter function operation mode Press and hold [ZERO] key with right hand Press [1] [0] [1][3] with left hand and release both hands Write [R + 1013] for the following	[ZERO] + [1][0][1][3]	0.000	0.000	0.00	0.00
2. Enter function operation mode Press and hold [ZERO] key with right hand and press [1] [4] [2]with left hand, and then release both hands Write [R + 142] for the following	[ZERO] + [1], [4], [2]		Sp500	1	1
3. Skip query, for example, query SP506, press[5] [0] [6] [X]	[5] [0] [6] [X]		Sp506	0	0
4. To modify SP506 content, replace 0 with 1, Press [1], [PRINT]	[1] [PRINT]		Sp507	0	0
5. Press [PLU],save and exit	[PLU]	0.000	0.000	0.00	0.00

7.7. How to realize that round up total price on transaction receipt to ten-cent

(Replace SP507=0 with SP0507=1(refer to following operation).

Description		Operation	Display			
R light on (transaction mode)			0.000	0.000	0.00	0.00
1.	Enter function operation mode					
	Press and hold [ZERO] key with right hand Press [1][0][1][3] with left hand and release both hands	[ZERO] + [1][0][1][3]				
	Write [R + 1013] for the following					
2.	Enter function operation mode					
	Press and hold [ZERO] key with right hand					
	Press [1], [4], [2] with left hand and release both hands	[ZERO] + [1],[4],[2]		Sp500	1	1
	Write [R + 142] for the following					
3.	Skip query, for example, query SP507, press[5][0][7][X]	[5][0][7][X]		Sp507	0	0
4.	To modify SP507 content, replace 0 with 1 and press [1], [PRINT] key	[1][PRINT]		Sp508	1	1
	Press [PLU],save and exit	[PLU]	0.000	0.000	0.00	0.00

Note: When SP507=1, round up total price on transaction receipt to ten-cent

7.8. How to modify printing of minimum weight value to achieve printing upon weight

Replace SP512=40 with SP0512=0(refer to following operation).

		Operation	Display			
R light on (transaction mode)			0.000	0.000	0.00	0.00
1.	Enter function operation mode Press and hold [ZERO] key with right hand Press [1][0][1][3] with left hand and release both hands Write [R + 1013] for the following	[ZERO] + [1][0][1][3]	0.000	0.000	0.00	0.00
2.	Enter function operation mode Press and hold [ZERO] key with right hand and press [1][4][2]with left hand, and then release both handsWrite [R + 142] for the following	[ZERO] + [1],[4],[2]		Sp500	1	1
3.	Skip query, for example, query SP512, press[5][1][2][X]	[5][1][2][X]		Sp512	40	40
	To modify SP512 content, replace 40 with 0, Press [0], [PRINT]	[0][PRINT]		Sp513	0	0
4.	Press [PLU],save and exit	[PLU]	0.000	0.000	0.00	0.00

7.9 How to realize printing of multiple copies of receipts

		Operation	Display			
R light on (transaction mode)			0.000	0.000	0.00	0.00
1.	Enter function operation mode					
	Press and hold [ZERO] key with right hand Press [1], [4], [1] with left hand and release both hands	[ZERO] + [1], [4], [1]		Sp001	21	21
	Write [R + 141] for the following					
2.	Skip query, for example, query SP170, press [1] [7] [0] [X]	[1] [7] [0] [X]		Sp170	0	0
3.	To modify SP170 content, replace 0 with 1, printing of 2 copies of receipts (Note: 0 is for one copy; 1 is for two copies)	[1] [PRINT]		Sp171	0	0
	Press [1], [PRINT]					
4.	Press [PLU], save and exit	[PLU]	0.000	0.000	0.00	0.00

7.10. How to realize reprinting of ticket

(Allocate reprint function key to shortcut key, for example: allocate reprint function key to P41 shortcut key)

	Operation	Display			
R light on (transaction mode)		0.000	0.000	0.00	0.00
1. Enter edit mode and press [MODE] key twice, (S1 commodity editing mode)	[MODE] [MODE]	S1	Edit		PLU
2. Enter function key allocation, press [1] [3] [X]	[1] [3] [X]	S13	Edit		FUNCKEY
Press [PRINT] key	[PRINT]	S13.0	FC.002	0	DISCANT
3. Press [-] select reprint function key	[-]...	S13.32	FC.104	0	REPRINT
4. Press P41 shortcut key, allocate reprint function key to P41 shortcut key	[P41]	S13.33	FC.105	0	CASH
5. Save, press [PLU] key	[PLU]	S13	Edit		FUNCKEY
6. Press [FEED] key, exit	[FEED]	0.000	0.000	0.00	0.00

Reprint operation: press [Reprint] key, to reprint the current ticket. Enter ticket number and press [Reprint] to reprint ticket of such ticket number.

7.11. How to realize sales return

(Allocate sales return function key to shortcut key, for example: allocate sales return function key to P42 shortcut key)

	Operation	Display			
R light on (transaction mode)		0.000	0.000	0.00	0.00
1. Enter edit mode and press [MODE] key twice,	[MODE] [MODE]	S1	Edit		PLU
2. Enter function key allocation, press [1] [3] [X]	[1] [3] [X]	S13	Edit		FUNCKEY
Press [PRINT] key	[PRINT]	S13.0	FC.002	0	DISCANT
5. Press [-] select reprint function key	[-]...	S13.35	FC.107	0	SALBACK
6. Press P42 shortcut key, allocate sales return function key to P42 shortcut key	[P42]	S13.36	FC.150	0	TRCCARD
7. Save,press [PLU] key	[PLU]	S13	Edit		FUNCKEY
8. Press [FEED] key, exit	[FEED]	0.000	0.000	0.00	0.00

Operation of sales return: After a transaction or an cumulative transactions, press [Sales Return] key and it displays "PAY SHOUD 0.00 10.00",press [PRINT] key to print ticket of sales return and press any key to go back.

VIII. The Error Message Table

The error message code is displayed in tare window of display and information description is displayed on information window of the dot matrix or the amount window

Errorcode	Description	
E000	db Err	Operation failure in system database
E001	No Sensor	No sensor signal
E012	PRINTER_OPENED	Print head is in open state
E013	PRINTER_NOPAPER	No paper
E014	PRINTER_LABELNOTMOVE	Label is not removed
E016	PRINTER_HOT	Printer head is overhot
E017	PRINTER_BUSY	Printer is busy
E018	PRINTER_PRINTER_ERROR	Printer communication error
E019	No Format	No label format
E020	INVALID_INPUT	Commodity PLUNO is not entered
E021	PLUNO_NOTFOUND	Commodity is not found
E023	LIMIT_NOTENOUGH	Insufficient weight limit of trace code
E024	PRINTER_PARAMNOTDETECT	Label parameter is not detected
E025	PRINTER_BUFFERFULL	Buffer area of printer is full
E026	TRACEINDEX_NOTFOUND	No. of trace code is not found
E027	PLUNO_CANNOESALE	Commodity is prohibited to sell
E028	SYSTEM_BUSY	System is busy
E031	DISAMT_MAX	Allowance amount error
E032	DISRAT_MAX	Discount rate error
E033	PAYAMT_TOSMALL	Payment amount is 0
E034	CHANGEAMT_TOBIG	Change amount error
E035	CHANGEAMT_INVALID	Invalid change amount
E036	PAYAMT_INVALID	Invalid payment amount
E037	TRACECARDDRIVER_INDEX_0 UTOFBOUNDS	Diver of traceability card is not found

E038	TRACECARDDRIVER_READ ERROR	Failure of traceability card reading
E039	TRACECARDDRIVER_READ BLCNO_NOTFOUND	Reference code is not found when traceability card is reading a commodity
E040	TRACECARDDRIVER_READ _TRACECODE_EXISTS	Traceability code existed when reading a traceability card
E041	TRACECARDDRIVER_READ _EMPTY	Card is empty when reading traceability code
E042	PREPAIDCARDRIVER_PAY_E RROR	Failure of prepaid card (similar to the Ma Da Sao Card) payment
E043	NOUSB	USB storage device is not found
E044	NOFILE	Upgrade package file is not found in USB storage device
E045	LOW BATTERY	Warnings of low battery and low voltage
E046		Failure of citizen card reading
E047	cant diScaMt	Allowance prohibited
E048	cant diScrat	Discount prohibited
E049	AMtoVEr	Label amount overflows (for label mode only)
E050		Failure of traceability card writing

DSR-100PE Series

ShangHai DB Scale Co.,Ltd

No.788 SongXiu Rd, QingPu District, ShangHai, PR.CHINA

Tel: 86-21-59757333 Fax: 86-21-59757058

<http://www.dbscale.com.cn>